

MP 5500/6500/7500
MP 5500/6500/7500
Aficio™ MP 5500/6500/7500
IS 2255/IS 2265/IS 2275

Operating Instructions General Settings Guide

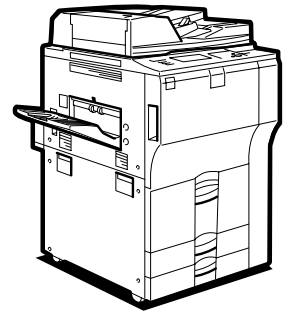

-
- 1** Connecting the Machine
 - 2** System Settings
 - 3** Copier/Document Server Features
 - 4** Printer Features
 - 5** Scanner Features
 - 6** Registering Addresses and Users for Scanner Functions
 - 7** Other User Tools
 - 8** Appendix

Introduction

This manual contains detailed instructions and notes on the operation and use of this machine. For your safety and benefit, read this manual carefully before using the machine. Keep this manual in a handy place for quick reference.

Important

Contents of this manual are subject to change without prior notice. In no event will the company be liable for direct, indirect, special, incidental, or consequential damages as a result of handling or operating the machine.



Notes:

Some illustrations in this manual might be slightly different from the machine.

Certain options might not be available in some countries. For details, please contact your local dealer.



Notes:

The model names of the machines do not appear in the following pages. Check the type of your machine before reading this manual.

- Type 1: MP 5500/Aficio MP 5500/IS 2255
- Type 2: MP 6500/Aficio MP 6500/IS 2265
- Type 3: MP 7500/Aficio MP 7500/IS 2275

Certain types might not be available in some countries. For details, please contact your local dealer.

Two kinds of size notation are employed in this manual. With this machine refer to the metric version.

Manuals for This Machine

Refer to the manuals that are relevant to what you want to do with the machine.

❖ **About This Machine**

Be sure to read the Safety Information in this manual before using the machine.

This manual provides an introduction to the functions of the machine. It also explains the control panel, preparation procedures for using the machine, how to enter text, and how to install the CD-ROMs provided.

❖ **General Settings Guide**

Explains User Tools settings, and Address Book procedures such as registering e-mail addresses, and user codes. Also refer to this manual for explanations on how to connect the machine.

❖ **Troubleshooting**

Provides a guide to solving common problems, and explains how to replace paper, toner, staples, and other consumables.

❖ **Security Reference**

This manual is for administrators of the machine. It explains security functions that the administrators can use to protect data from being tampered, or prevent the machine from unauthorized use.

Also refer to this manual for the procedures for registering administrators, as well as setting user and administrator authentication.

❖ **Copy/ Document Server Reference**

Explains Copier and Document Server functions and operations. Also refer to this manual for explanations on how to place originals.

❖ **Printer Reference**

Explains Printer functions and operations.

❖ **Scanner Reference**

Explains Scanner functions and operations.

❖ **Network Guide**

Explains how to configure and operate the machine in a network environment, and use the software provided.

This manual covers all models, and includes descriptions of functions and settings that might not be available on this machine. Images, illustrations, and information about operating systems that are supported might also differ slightly from those of this machine.

❖ Other manuals

- Quick Reference Copy Guide
- Quick Reference Printer Guide
- Quick Reference Scanner Guide
- PostScript3 Supplement
- UNIX Supplement
- Manuals for DeskTopBinder Lite
 - DeskTopBinder Lite Setup Guide
 - DeskTopBinder Introduction Guide
 - Auto Document Link Guide

Note

- Manuals provided are specific to machine types.
- Adobe Acrobat Reader/Adobe Reader must be installed in order to view the manuals as PDF files.
- For "UNIX Supplement", please visit our Web site or consult an authorized dealer.
- "PostScript3 Supplement" and "UNIX Supplement" include descriptions of functions and settings that might not be available on this machine.

TABLE OF CONTENTS

Manuals for This Machine	i
How to Read This Manual	1
Symbols	1
Display panel	2
Accessing User Tools (System Settings)	3
Changing Default Settings	3
Quitting User Tools	4
About Menu Protect	4

1. Connecting the Machine

Connecting to the Interfaces	5
Connecting to the Ethernet Interface	6
Connecting to the USB Interface	8
Connecting to the IEEE 1394 Interface	9
Connecting to the IEEE 1284 Interface	9
Connecting to the IEEE 802.11b (Wireless LAN) Interface	10
Network Settings	14
Settings Required to Use the Printer	14
Settings Required to Use E-mail Function	17
Settings Required to Use Scan to Folder Function	21
Settings Required to Use the Network Delivery Scanner	24
Settings Required to Use Network TWAIN Scanner	27
Settings Required to Use Document Server	30
Using Utilities to Make Settings	33

2. System Settings

General Features	41
Output tray settings	45
Tray Paper Settings	46
Timer Settings	52
Interface Settings	55
Network	55
Parallel Interface	59
IEEE 1394	60
IEEE 802.11b	62
Print List	64
File Transfer	65
Administrator Tools	71
Program / Change / Delete LDAP Server	80
Programming the LDAP server	81
System Settings on Main and Sub-machines	86
General Features	86
Tray Paper Settings	88
Timer Settings	89
Administrator Tools	90

3. Copier/Document Server Features

General Features	95
Reproduction Ratio	102
Edit	106
Stamp	111
Background Numbering	111
Preset Stamp	112
User Stamp	114
Date Stamp	116
Page Numbering	117
Stamp Text.....	120
Input/Output	122
Settings for the Document Server	125
Copier/Document Server Features on Main and Sub-machines	127
General Features	127
Reproduction Ratio	129
Edit	129
Stamp.....	132
Input/Output	135

4. Printer Features

List/Test Print	137
Printing the configuration page	138
Interpreting the configuration page	138
Maintenance	140
System	141
Host Interface	147
PCL Menu	148
PS Menu	150
PDF Menu	151

5. Scanner Features

General Settings	153
Scan Settings	155
Send Settings	157

6. Registering Addresses and Users for Scanner Functions

Address Book	159
Managing names in the Address Book	161
Sending e-mail by Quick Dial	162
Sending scanned files to a shared folder directly.....	162
Preventing unauthorized user access to shared folders from the machine	162
Managing users and machine usage	162
Registering Names	163
Registering Names.....	163
Changing a Registered Name.....	165
Deleting a Registered Name	166

Authentication Information	167
Registering a User Code	168
Changing a User Code.....	169
Deleting a User Code	171
Displaying the Counter for Each User	172
Printing the Counter for Each User	173
Printing the Counter for All User	174
Clearing the Number of Prints.....	175
E-mail Destination.....	177
Registering an E-mail Destination.....	177
Changing an E-mail Destination.....	179
Deleting an E-mail Destination.....	180
Registering Folders	181
Using SMB to Connect.....	181
Using FTP to Connect.....	188
Using NCP to Connect.....	193
Registering Names to a Group	199
Registering a Group	199
Registering Names to a Group.....	201
Adding a Groupe to Another Group	202
Displaying Names Registered in a Group	203
Removing a Name from a Group	204
Deleting a Group Within Atanother Group	205
Changing a Group Name	207
Deleting a Goup	208
Registering a Protection Code	209
Registering a Protection Code to a Single User.....	209
Registering a Protection Code to a Group User.....	211
Registering SMTP and LDAP Authentication.....	212
SMTP Authentication	212
LDAP Authentication	214

7. Other User Tools

Changing the Display Language	217
Enquiry.....	218
Counter	220
Displaying the Total Counter.....	220

8. Appendix

Specifications for the Main Unit	221
Document Server	225
Auto Document Feeder	226

- Specifications for Options 227**
 - Mailbox.....227
 - Booklet Finisher228
 - 3,000Sheet-50Sheet Staple Finisher231
 - 3,000Sheet-100Sheet Staple Finisher233
 - Punch Unit (Booklet Finisher, 3,000Sheet-50Sheet Staple Finisher)235
 - Punch Unit (3,000Sheet-100Sheet Staple Finisher)236
 - Z-folding unit237
 - Copy tray.....237
 - Large Capacity Tray (LCT).....238
 - Interposer.....238
- Specifications for Others 239**
- Information about Installed Software..... 240**
 - expat240
 - NetBSD240
 - Sablotron.....242
 - JPEG LIBRARY243
 - SASL.....243
 - MD4.....244
 - MD5.....244
 - Samba(Ver 3.0.4).....245
 - RSA BSAFE®245
 - Open SSL.....246
 - Open SSH.....248
 - Open LDAP253
- INDEX..... 255**

How to Read This Manual

Symbols

This manual uses the following symbols:

 **WARNING:**

Indicates important safety notes.

Ignoring these notes could result in serious injury or death. Be sure to read these notes. They can be found in the "Safety Information" section of About This Machine.

 **CAUTION:**

Indicates important safety notes.

Ignoring these notes could result in moderate or minor injury, or damage to the machine or to property. Be sure to read these notes. They can be found in the "Safety Information" section of About This Machine.

 **Important**

Indicates points to pay attention to when using the machine, and explanations of likely causes of paper misfeeds, damage to originals, or loss of data. Be sure to read these explanations.

 **Note**

Indicates supplementary explanations of the machine's functions, and instructions on resolving user errors.

 **Reference**

This symbol is located at the end of sections. It indicates where you can find further relevant information.

[]

Indicates the names of keys that appear on the machine's display panel.

[]

Indicates the names of keys on the machine's control panel.

Display panel

The display panel shows machine status, error messages, and function menus.

The function items displayed serve as selector keys. You can select or specify an item by lightly pressing them.

When you select or specify an item on the display panel, it is highlighted like **Off**. Keys appearing as **○ K** cannot be used.

Important

A force or impact of more than 30 N (about 3 kgf) will damage the display panel.

To display the following screen, press the **[User Tools/Counter]** key to display the User Tools menu, and then press **[System Settings]**.

Using the System Settings menu screen as an example, this section explains how to use the machine's control panel.

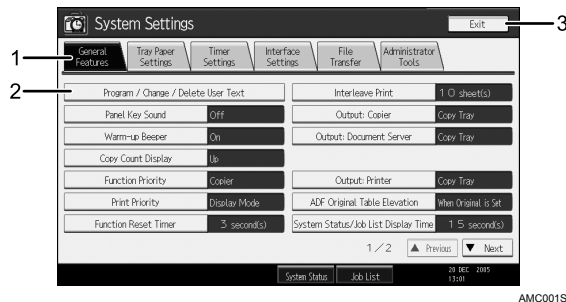

AMC001S

1. The menu tabs for various settings appear. To display the setting you want to specify or change, press the appropriate menu tab.

2. A list of settings appears. To display the setting you want to specify or change, select the appropriate entry in the list.

3. Press this to close the User Tools menu.

Accessing User Tools (System Settings)

This section is for Administrators in charge of this machine.

User Tools allow you to change or set defaults.

Note

- Operations for system settings differ from normal operations. Always quit User Tools when you have finished.
- Any changes you make with User Tools remain in effect even if the main power switch or operation switch is turned off, or the **[Energy Saver]** or **[Clear Modes]** key is pressed.

Reference

p.4 "Quitting User Tools"

Changing Default Settings

This section describes how to change the settings of User Tools.

Important

- If the Administrator Authentications specified, contact your administrator.

1 Press the **[User Tools/Counter]** key.

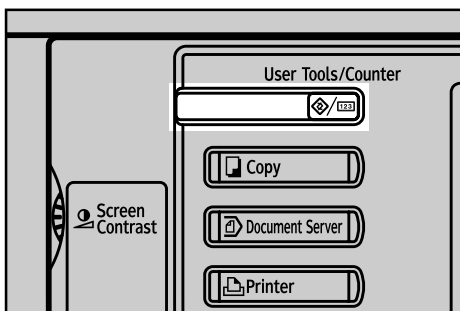

2 Select the menu.

To change the System Settings, Press **[System Settings]**.

To change the Copier/Document Server Features, Press **[Copier / Document Server Features]**.

To change the Printer Features, Press **[Printer Features]**.

To change the Scanner Features, Press **[Scanner Features]**.

To change the displayed language, press **[Français]** or **[English]**.

To find out who to contact for maintenance and where to order consumables, press **[Enquiry]**.

To check the counter, press **[Counter]**.

3 Select the menu tab.

4 Change settings by following instructions on the display, and then press [OK].

 **Note**

- To cancel changes made to settings and return to the initial display, press the **[User Tools/Counter]** key.

 **Reference**

- p.41 “System Settings”
- p.95 “Copier/Document Server Features”
- p.137 “Printer Features”
- p.153 “Scanner Features”
- p.217 “Other User Tools”

Quitting User Tools

This section describes how to end User Tools.

1 Press the **[User Tools/Counter]** key.

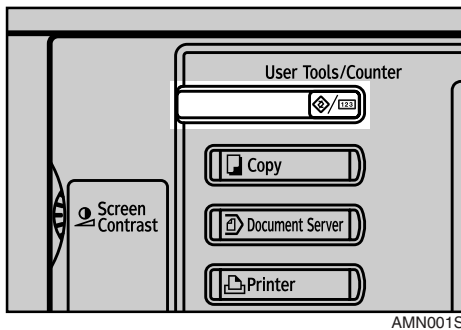

 **Note**

- You can also quit User Tools by pressing **[Exit]**.

About Menu Protect

Using Menu Protect, you can limit the settings available to users other than the administrator. In the following User Tools menus, you can specify Menu Protect for each setting.

- Copier/Document Server Features
- Printer Features
- Scanner Features

For details about menu protect, contact your administrator.

1. Connecting the Machine

Connect the machine to the network to configure network environment.

Connecting to the Interfaces

This section explains how to check the machine's interface, connect the machine according to the network environment, and specify the network settings.

When the IEEE 1394 interface board (optional) is installed.

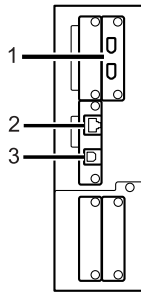

When the IEEE 1284 interface board (optional) is installed.

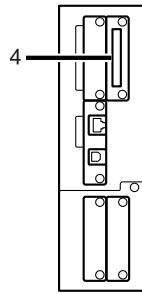

When the wireless LAN board (optional) is installed.

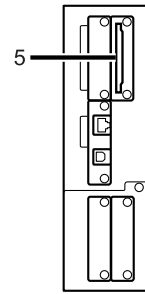

AMC004S

1. IEEE 1394 ports (optional)

Ports for connecting the IEEE 1394 interface cable

2. 10BASE-T/100BASE-TX port

Port for connecting the 100BASE-TX or 10BASE-T cable

Port for connecting the 1000BASE-T, 100BASE-TX or 10BASE-T cable when the Gigabit Ethernet (Optional) is installed

3. USB2.0 port

Port for connecting the USB2.0 interface cable

4. IEEE 1284 port (optional)

Port for connecting the IEEE 1284 interface cable

5. Wireless LAN port (optional)

Port for using the wireless LAN

Note

- You cannot install two or more of the options below: IEEE 1394 interface board, IEEE 1284 interface board, IEEE 802.11b wireless LAN

Connecting to the Ethernet Interface

Connect 10BASE-T or 100BASE-TX cable to the Ethernet interface.

1

Important

If the main power switch is turned "On", turn it "Off".

1 A ferrite core for the Ethernet cable is supplied with this machine. The Ethernet cable loop should be about 15 cm (5.9 inch) (1) from the machine end of the cable.

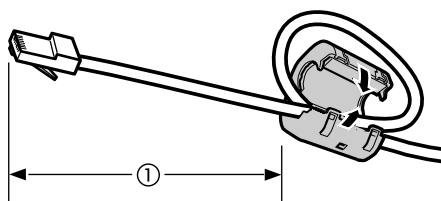

AEV047S

2 Make sure the main power switch on the machine is "Off".

3 Connect the Ethernet interface cable to the 10BASE-T/100BASE-TX port.

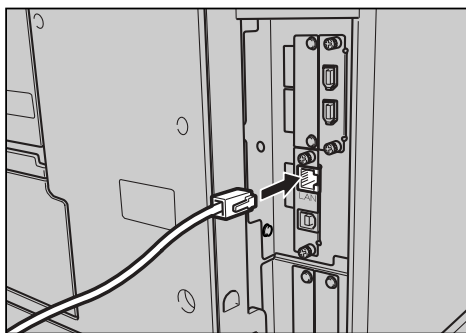

AMM007S

4 Connect the other end of the Ethernet cable to a network connection device such as a hub.

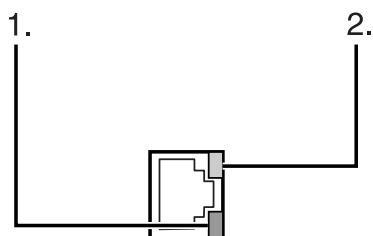
5 Turn the main power switch of the machine on.

AMM008S

- ① Indicator (green)
Remains green when the machine is properly connected to the network.
- ② Indicator (yellow)
Turns yellow when 100 BASE-TX is operating. Turns off when 10 BASE-T is operating.

🔍 Reference

"Turning On the Power" About This Machine

"Preparing the Machine" Printer Reference

Connecting to the USB Interface

Connect the USB2.0 interface cable to the USB2.0 port.

1

1 Connect the USB 2.0 interface cable to the USB2.0 port.

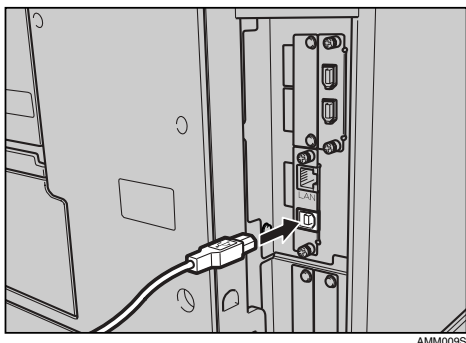

2 Connect the other end to the USB port on the host computer.

 **Note**

- Purchase a USB cable separately according to a personal computer in use.
- The USB 2.0 interface board is supported by Windows Me / 2000 / XP, Windows Server 2003, Mac OS X v10.3.3 or higher.
 - For Windows Me:
Make sure to install "USB Printing Support". If USB 2.0 is used with Windows Me, only a speed equal to that of USB 1.1 is possible.
 - For Mac OS:
To use Macintosh, the machine must be equipped with the optional PostScript 3 unit. If USB 2.0 is used with Mac OS X v10.3.3 or higher, a transfer speed of USB 2.0 is supported.
- For details about installing the printer driver, see "Preparing the Machine" Printer Reference.

 **Reference**

"Preparing the Machine" Printer Reference

Connecting to the IEEE 1394 Interface

Connect the IEEE 1394 interface cable to the IEEE 1394 interface board.

- 1 Connect the IEEE 1394 interface cable to the IEEE 1394 port.

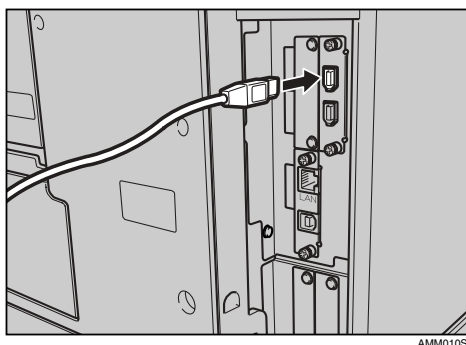

- 2 For IEEE 1394 (SCSI print) connection, plug the other end of the cable into the interface connector on the host computer.

Make sure about the shape of the connector to the computer. Fasten the connector securely to the computer.

Note

- Use the interface cable supplied with the IEEE 1394 interface board (optional).
- Make sure the interface cable is not looped.
- Two interface ports are available for connecting the IEEE 1394 interface cable. Either is suitable.
- For details about installing the printer driver, see "Preparing the Machine" Printer Reference.

Reference

"Turning On the Power" About this machine

"Preparing the Machine" Printer Reference

Connecting to the IEEE 1284 Interface

Connect the IEEE 1284 interface cable to the IEEE 1284 interface board.

- 1 Make sure the main power switch on the machine is "Off".

If the main power switch is turned "On", turn it "Off".

- 2 Turn off the main power switch of the host computer

3 Connect the IEEE 1284 interface cable to the IEEE 1284 port.

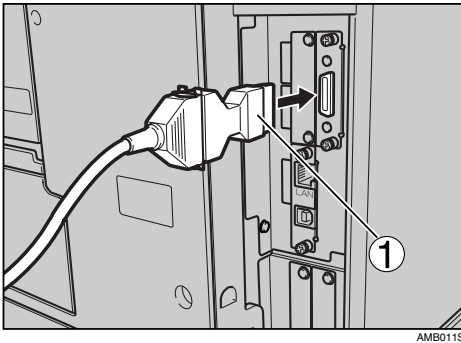

To make the connection, use the conversion connector (1) supplied with the IEEE 1284 interface board.

4 Plug the other end of the cable into the interface connector on the host computer.

Make sure about the shape of the connector to the computer. Fasten the connector securely to the computer.

5 Turn the main power switch of the machine "On".

6 Turn on the host computer.

When using Windows 95/98/Me/2000/XP and Windows Server 2003, a printer driver installation screen might appear when the computer is turned on. If this happens, click **[Cancel]** on the screen.

 **Note**

- For details about installing the printer driver, see "Preparing the Machine" Printer Reference

 **Reference**

- "Turning On the Power" About this machine
- "Preparing the Machine" Printer Reference

Connecting to the IEEE 802.11b (Wireless LAN) Interface

Connecting to the IEEE 802.11b (wireless LAN) interface.

 **Note**

- Check the setting of IPv4 address and subnet mask of this machine.
- For how to set IPv4 address and subnet mask from the control panel of the machine, see "Interface Settings".

 **Reference**

- p.55 "Network"

Setup Procedure

Setup IEEE 802.11b (wireless LAN) according to the following flow:

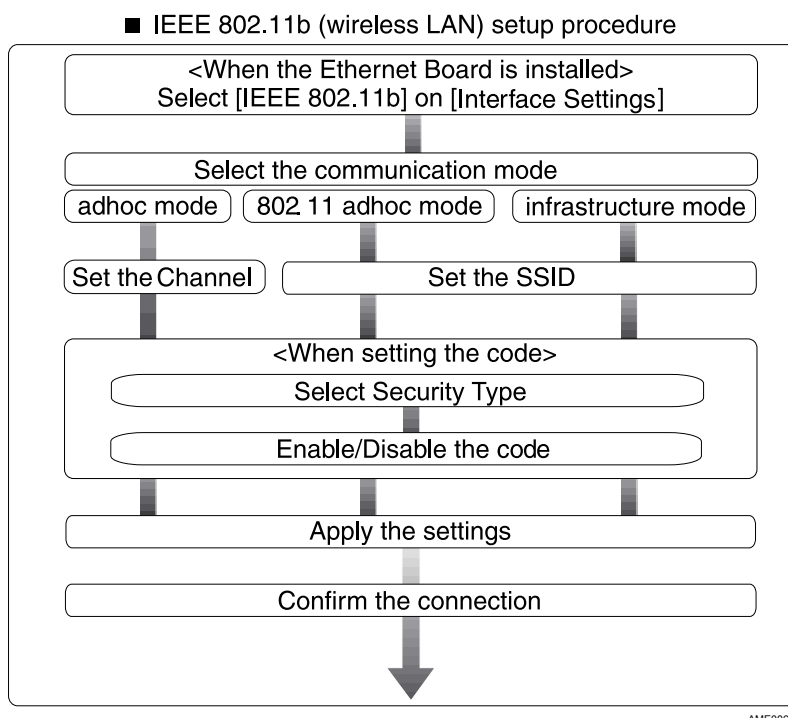

Note

- ❑ Select **[802.11 Ad-hoc Mode]** when connecting Windows XP as a wireless LAN client using Windows XP standard driver or utilities, or when not using the infrastructure mode.
- ❑ For details about how to make settings of wireless LAN from the control panel on the machine, see "IEEE 802.11b".
- ❑ For details about how to make settings of wireless LAN from other than the control panel on the machine, see "Using Utilities to Make Settings".
- ❑ For details about the setting items, see "IEEE 802.11b".

Reference

p.62 "IEEE 802.11b"

p.33 "Using Utilities to Make Settings"

Checking the Connection

Check the wireless LAN connection.

Make sure the LED of the IEEE 802.11b interface unit is lit.

1

❖ When using in infrastructure mode

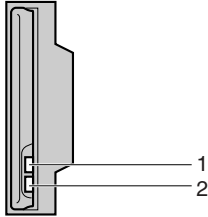

ZGDH600J

1. If [LAN Type] on the [Interface Settings] / [Network] screen is not set to [IEEE 802.11b], it does not light, even if the main power is on.

2. If it is connected properly to the network, the LED is green when in infrastructure mode. If the LED is blinking, the machine is searching for devices.

❖ When using in adhoc mode / 802.11 adhoc mode

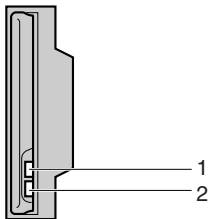

ZGDH600J

1. If the IEEE 802.11b interface unit is working, it is lit in orange.

2. If it is connected properly to the network, the LED is green when in adhoc mode or 802.11 adhoc mode. If the LED is blinking, the machine is searching for devices. The LED will light after a few seconds.

Print the configuration page to verify settings.

Note

For more information about printing a configuration page, see "Print List".

Reference

p.138 "Printing the configuration page"

Checking the Signal

When using in infrastructure mode, you can check the machine's radio wave status using the control panel.

- ① Press **[System Settings]**.
- ② Press **[Interface Settings]**.
- ③ Press **[IEEE 802.11b]**.
- ④ Press **[Wireless LAN Signal]**.
The machine's radio wave status appears.
- ⑤ After checking radio wave status, press **[Exit]**.
- ⑥ Press the **[User Tools/Counter]** key to return to the User Tools / Counter / Enquiry menu.

 **Note**

- To check the radio wave status, press **[IEEE 802.11b]** under **[LAN Type]** on the **[Network]** screen.

Network Settings

This section describes the network settings you can change with User Tools (System Settings). Make settings according to functions you want to use and the interface to be connected.

Important

- ❑ These settings should be made by the systems administrator, or after consulting with the systems administrator.

Settings Required to Use the Printer

This section lists the settings required for using the printer function.

Ethernet

This section lists the settings required for using the printer function with an Ethernet connection.

For details about specifying the settings, see "Interface Settings".

Heading	Setting Item	Setting Requirements
Interface Settings/Network	Machine IPv4 Address	Mandatory
Interface Settings/Network	IPv4 Gateway Address	As required
Interface Settings/Network	Machine IPv6 Address	As required
Interface Settings/Network	IPv6 Gateway Address	As required
Interface Settings/Network	IPv6 Stateless Address Autoconfiguration	As required
Interface Settings/Network	DNS Configuration	As required
Interface Settings/Network	DDNS Configuration	As required
Interface Settings/Network	Domain Name	As required
Interface Settings/Network	WINS Configuration	As required
Interface Settings/Network	Effective Protocol	Mandatory
Interface Settings/Network	NCP Delivery Protocol	As required
Interface Settings/Network	NW Frame Type	As required
Interface Settings/Network	SMB Computer Name	As required
Interface Settings/Network	SMB Work Group	As required
Interface Settings/Network	Ethernet Speed	As required
Interface Settings/Network	LAN Type	Mandatory
Interface Settings/Network	Permit SNMPv3 Communication	As required
Interface Settings/Network	Permit SSL/TLS Communication	As required
Interface Settings/Network	Host Name	As required

Heading	Setting Item	Setting Requirements
Interface Settings/Network	Machine Name	As required

Note

- IPv6 can be used only for the printer function.
- In **[Effective Protocol]**, check that the protocol you want to use is set to **[Active]**.
- [LAN Type]** is displayed when optional wireless LAN board is installed. If Ethernet and IEEE 802.11b (wireless LAN) are both connected, the selected interface has priority.

Reference

p.55 "Interface Settings"

p.65 "File Transfer"

IEEE 1394 (IPv4 over 1394)

This section describes necessary set items for using Printer with IEEE 1394 interface cable.

For details about specifying the settings, see "Interface Settings" and "File Transfer".

Heading	Setting Item	Setting Requirements
Interface Settings/IEEE 1394	IPv4 Address	Mandatory
Interface Settings/IEEE 1394	DDNS Configuration	As required
Interface Settings/IEEE 1394	Host Name	As required
Interface Settings/IEEE 1394	Domain Name	As required
Interface Settings/IEEE 1394	WINS Configuration	As required
Interface Settings/IEEE 1394	IPv4 over 1394	Mandatory
Interface Settings/Network	IPv4 Gateway Address	As required
Interface Settings/Network	DNS Configuration	As required
Interface Settings/Network	Effective Protocol	Mandatory

Note

- [IEEE 1394]** appears when optional IEEE 1394 interface board is installed.
- As to **[Effective Protocol]**, check if the protocol to use is set as **[Active]**.

Reference

p.55 "Interface Settings"

p.65 "File Transfer"

IEEE 802.11b (wireless LAN)

This section describes necessary set items for using Printer with IEEE 802.11b (wireless LAN).

For details about specifying the settings, see "Interface Settings" and "File Transfer".

Heading	Setting Item	Setting Requirements
Interface Settings/Network	Machine IPv4 Address	Mandatory
Interface Settings/Network	IPv4 Gateway Address	As required
Interface Settings/Network	Machine IPv6 Address	As required
Interface Settings/Network	IPv6 Gateway Address	As required
Interface Settings/Network	IPv6 Stateless Address Autoconfiguration	As required
Interface Settings/Network	DNS Configuration	As required
Interface Settings/Network	DDNS Configuration	As required
Interface Settings/Network	Domain Name	As required
Interface Settings/Network	WINS Configuration	As required
Interface Settings/Network	Effective Protocol	Mandatory
Interface Settings/Network	NCP Delivery Protocol	As required
Interface Settings/Network	NW Frame Type	As required
Interface Settings/Network	SMB Computer Name	As required
Interface Settings/Network	SMB Work Group	As required
Interface Settings/Network	LAN Type	Mandatory
Interface Settings/Network	Permit SNMPv3 Communication	As required
Interface Settings/Network	Permit SSL/TLS Communication	As required
Interface Settings/Network	Host Name	As required
Interface Settings/Network	Machine Name	As required
Interface Settings/ IEEE 802.11b	Communication Mode	Mandatory
Interface Settings/ IEEE 802.11b	SSID Setting	As required
Interface Settings/ IEEE 802.11b	Channel	As required
Interface Settings/ IEEE 802.11b	Security Method	As required
Interface Settings/ IEEE 802.11b	Transmission Speed	As required

 **Note**

- As to **[Effective Protocol]**, check if the protocol to use is set as **[Active]**.
- [IEEE 802.11b]** and **[LAN Type]** are displayed when optional wireless LAN interface board is installed. If both Ethernet and wireless LAN (IEEE 802.11b) are connected, the selected interface takes precedence.

 **Reference**

p.55 "Interface Settings"

p.65 "File Transfer"

Settings Required to Use E-mail Function

This section describes necessary set items for sending e-mail.

Ethernet

This section describes necessary set items for sending e-mail with Ethernet cable. For details about specifying the settings, see "Interface Settings" and "File Transfer".

Heading	Setting Item	Setting Requirements
Interface Settings/Network	Machine IPv4 Address	Mandatory
Interface Settings/Network	IPv4 Gateway Address	Mandatory
Interface Settings/Network	DNS Configuration	As required
Interface Settings/Network	DDNS Configuration	As required
Interface Settings/Network	Domain Name	As required
Interface Settings/Network	WINS Configuration	As required
Interface Settings/Network	Effective Protocol	Mandatory
Interface Settings/Network	Ethernet Speed	As required
Interface Settings/Network	LAN Type	Mandatory
Interface Settings/Network	Permit SNMPv3 Communication	As required
Interface Settings/Network	Permit SSL/TLS Communication	As required
Interface Settings/Network	Host Name	As required
File Transfer	SMTP Server	Mandatory
File Transfer	SMTP Authentication	As required
File Transfer	POP before SMTP	As required
File Transfer	Reception Protocol	As required
File Transfer	POP3/IMAP4 Settings	As required
File Transfer	Administrator's E-mail Address	As required
File Transfer	E-mail Communication Port	As required
File Transfer	Program / Change / Delete E-mail Message	As required

Heading	Setting Item	Setting Requirements
File Transfer	Scanner Resend Interval Time	As required
File Transfer	Number of Scanner Resends	As required

Note

- As to **[Effective Protocol]**, check if the protocol to use is set as **[Active]**.
- [LAN Type]** is displayed when optional wireless LAN interface board is installed. If both ethernet and wireless LAN (IEEE 802.11b) are connected, the selected interface takes precedence.
- When setting **[POP before SMTP]** to **[On]**, also make setting for **[Reception Protocol]** and **[POP3 / IMAP4 Settings]**.
- When setting **[POP before SMTP]** to **[On]**, check **[POP3]** port number in **[E-mail Communication Port]**.

Reference

p.55 "Interface Settings"

p.65 "File Transfer"

IEEE 1394 (IPv4 over 1394)

This section describes necessary set items for sending e-mail with IEEE 1394 interface cable.

For details about specifying the settings, see "Interface Settings" and "File Transfer".

Heading	Setting Item	Setting Requirements
Interface Settings/IEEE 1394	IPv4 Address	Mandatory
Interface Settings/IEEE 1394	DDNS Configuration	As required
Interface Settings/IEEE 1394	Host Name	As required
Interface Settings/IEEE 1394	Domain Name	As required
Interface Settings/IEEE 1394	WINS Configuration	As required
Interface Settings/IEEE 1394	IPv4 over 1394	Mandatory
Interface Settings/Network	IPv4 Gateway Address	Mandatory
Interface Settings/Network	DNS Configuration	As required
Interface Settings/Network	Effective Protocol	Mandatory
File Transfer	SMTP Server	Mandatory
File Transfer	SMTP Authentication	As required
File Transfer	POP before SMTP	As required
File Transfer	Reception Protocol	As required
File Transfer	POP3/IMAP4 Settings	As required
File Transfer	Administrator's E-mail Address	As required
File Transfer	E-mail Communication Port	As required

Heading	Setting Item	Setting Requirements
File Transfer	Program / Change / Delete E-mail Message	As required
File Transfer	Scanner Resend Interval Time	As required
File Transfer	Number of Scanner Resends	As required

Note

- [IEEE 1394] is displayed when optional IEEE 1394 interface board is installed.
- As to [Effective Protocol], check if the protocol to use is set as [Active].
- When setting [POP before SMTP] to [On], also make setting for [Reception Protocol] and [POP3 / IMAP4 Settings].
- When setting [POP before SMTP] to [On], check [POP3] port number in [E-mail Communication Port].

Reference

p.55 "Interface Settings"

p.65 "File Transfer"

IEEE 802.11b (wireless LAN)

This section describes necessary set items for sending e-mail with IEEE 802.11b (wireless LAN).

For details about specifying the settings, see "Interface Settings" and "File Transfer".

Heading	Setting Item	Setting Requirements
Interface Settings/Network	Machine IPv4 Address	Mandatory
Interface Settings/Network	IPv4 Gateway Address	Mandatory
Interface Settings/Network	DNS Configuration	As required
Interface Settings/Network	DDNS Configuration	As required
Interface Settings/Network	Domain Name	As required
Interface Settings/Network	WINS Configuration	As required
Interface Settings/Network	Effective Protocol	Mandatory
Interface Settings/Network	LAN Type	Mandatory
Interface Settings/Network	Permit SNMPv3 Communication	As required
Interface Settings/Network	Permit SSL/TLS Communication	As required
Interface Settings/Network	Host Name	As required
Interface Settings/ IEEE 802.11b	Communication Mode	Mandatory
Interface Settings/ IEEE 802.11b	SSID Setting	As required
Interface Settings/ IEEE 802.11b	Channel	As required

Heading	Setting Item	Setting Requirements
Interface Settings/ IEEE 802.11b	Security Method	As required
Interface Settings/ IEEE 802.11b	Transmission Speed	As required
File Transfer	SMTP Server	Mandatory
File Transfer	SMTP Authentication	As required
File Transfer	POP before SMTP	As required
File Transfer	Reception Protocol	As required
File Transfer	POP3/IMAP4 Settings	As required
File Transfer	Administrator's E-mail Address	As required
File Transfer	E-mail Communication Port	As required
File Transfer	Program / Change / Delete E-mail Message	As required
File Transfer	Scanner Resend Interval Time	As required
File Transfer	Number of Scanner Resends	As required

Note

- As to **[Effective Protocol]**, check if the protocol to use is set as **[Active]**.
- [LAN Type]** is displayed when optional wireless LAN interface board is installed. If both ethernet and wireless LAN (IEEE 802.11b) are connected, the selected interface takes precedence.
- When setting **[POP before SMTP]** to **[On]**, also make setting for **[Reception Protocol]** and **[POP3 / IMAP4 Settings]**.
- When setting **[POP before SMTP]** to **[On]**, check **[POP3]** port number in **[E-mail Communication Port]**.

Reference

p.55 "Interface Settings"

p.65 "File Transfer"

Settings Required to Use Scan to Folder Function

This section describes necessary set items for sending file.

Ethernet

This section describes necessary set items for sending file with ethernet cable. For details about specifying the settings, see "Interface Settings" and "File Transfer".

Heading	Setting Item	Setting Requirements
Interface Settings/Network	Machine IPv4 Address	Mandatory
Interface Settings/Network	IPv4 Gateway Address	Mandatory
Interface Settings/Network	DNS Configuration	As required
Interface Settings/Network	DDNS Configuration	As required
Interface Settings/Network	Domain Name	As required
Interface Settings/Network	WINS Configuration	As required
Interface Settings/Network	Effective Protocol	Mandatory
Interface Settings/Network	Ethernet Speed	As required
Interface Settings/Network	LAN Type	Mandatory
Interface Settings/Network	Permit SNMPv3 Communication	As required
Interface Settings/Network	Permit SSL/TLS Communication	As required
Interface Settings/Network	Host Name	As required
File Transfer	Scanner Resend Interval Time	As required
File Transfer	Number of Scanner Resends	As required

Note

- As to **[Effective Protocol]**, check if the protocol to use is set as **[Active]**.
- [LAN Type]** is displayed when optional wireless LAN interface board is installed. If both ethernet and wireless LAN (IEEE 802.11b) are connected, the selected interface takes precedence.

Reference

p.55 "Interface Settings"

p.65 "File Transfer"

IEEE 1394 (IPv4 over 1394)

This section describes necessary set items for sending file with IEEE 1394 interface cable.

For details about specifying the settings, see "Interface Settings" and "File Transfer".

Heading	Setting Item	Setting Requirements
Interface Settings/IEEE 1394	IPv4 Address	Mandatory
Interface Settings/IEEE 1394	DDNS Configuration	As required
Interface Settings/IEEE 1394	Host Name	As required
Interface Settings/IEEE 1394	Domain Name	As required
Interface Settings/IEEE 1394	WINS Configuration	As required
Interface Settings/IEEE 1394	IPv4 over 1394	Mandatory
Interface Settings/Network	IPv4 Gateway Address	Mandatory
Interface Settings/Network	DNS Configuration	As required
Interface Settings/Network	Effective Protocol	Mandatory
File Transfer	Scanner Resend Interval Time	As required
File Transfer	Number of Scanner Resends	As required

Note

- [IEEE 1394]** is displayed when optional IEEE 1394 interface board is installed.
- As to **[Effective Protocol]**, check if the protocol to use is set as **[Active]**.

Reference

p.55 "Interface Settings"

p.65 "File Transfer"

IEEE 802.11b (wireless LAN)

This section describes necessary set items for sending file with IEEE 802.11b (wireless LAN).

For details about specifying the settings, see "Interface Settings" and "File Transfer".

Heading	Setting Item	Setting Requirements
Interface Settings/Network	Machine IPv4 Address	Mandatory
Interface Settings/Network	IPv4 Gateway Address	Mandatory
Interface Settings/Network	DNS Configuration	As required
Interface Settings/Network	DDNS Configuration	As required
Interface Settings/Network	Domain Name	As required
Interface Settings/Network	WINS Configuration	As required
Interface Settings/Network	Effective Protocol	Mandatory
Interface Settings/Network	LAN Type	Mandatory
Interface Settings/Network	Permit SNMPv3 Communication	As required
Interface Settings/Network	Permit SSL/TLS Communication	As required
Interface Settings/Network	Host Name	As required
Interface Settings/ IEEE 802.11b	Communication Mode	Mandatory
Interface Settings/ IEEE 802.11b	SSID Setting	As required
Interface Settings/ IEEE 802.11b	Channel	As required
Interface Settings/ IEEE 802.11b	Security Method	As required
Interface Settings/ IEEE 802.11b	Transmission Speed	As required
File Transfer	Scanner Resend Interval Time	As required
File Transfer	Number of Scanner Resends	As required

Note

- As to **[Effective Protocol]**, check if the protocol to use is set as **[Active]**.
- [IEEE 802.11b]** and **[LAN Type]** are displayed when optional wireless LAN interface board is installed. If both ethernet and wireless LAN (IEEE 802.11b) are connected, the selected interface takes precedence.

Reference

p.55 "Interface Settings"

p.65 "File Transfer"

Settings Required to Use the Network Delivery Scanner

This section describes necessary set items for delivering data to network.

Ethernet

This section describes necessary set items for delivering data to network with ethernet cable.

For details about specifying the settings, see "Interface Settings" and "File Transfer".

Heading	Setting Item	Setting Requirements
Interface Settings/Network	Machine IPv4 Address	Mandatory
Interface Settings/Network	IPv4 Gateway Address	As required
Interface Settings/Network	DNS Configuration	As required
Interface Settings/Network	DDNS Configuration	As required
Interface Settings/Network	Domain Name	As required
Interface Settings/Network	WINS Configuration	As required
Interface Settings/Network	Effective Protocol	Mandatory
Interface Settings/Network	Ethernet Speed	As required
Interface Settings/Network	LAN Type	Mandatory
Interface Settings/Network	Permit SNMPv3 Communication	As required
Interface Settings/Network	Permit SSL/TLS Communication	As required
Interface Settings/Network	Host Name	As required
File Transfer	Delivery Option	As required
File Transfer	Scanner Resend Interval Time	As required
File Transfer	Number of Scanner Resends	As required

Note

- As to **[Effective Protocol]**, check if the protocol to use is set as **[Active]**.
- [LAN Type]** is displayed when optional wireless LAN interface board is installed. When both ethernet and wireless LAN (IEEE 802.11b) are connected, the selected interface takes precedence.
- If **[Delivery Option]** is set to **[On]**, check that IPv4 Address is set.

Reference

p.55 "Interface Settings"

p.65 "File Transfer"

IEEE 1394 (IPv4 over 1394)

This section describes necessary set items for delivering data to network with IEEE 1394 interface cable.

For details about specifying the settings, see "Interface Settings" and "File Transfer".

Heading	Setting Item	Setting Requirements
Interface Settings/IEEE 1394	IPv4 Address	Mandatory
Interface Settings/IEEE 1394	DDNS Configuration	As required
Interface Settings/IEEE 1394	Host Name	As required
Interface Settings/IEEE 1394	Domain Name	As required
Interface Settings/IEEE 1394	WINS Configuration	As required
Interface Settings/IEEE 1394	IPv4 over 1394	Mandatory
Interface Settings/Network	IPv4 Gateway Address	As required
Interface Settings/Network	DNS Configuration	As required
Interface Settings/Network	Effective Protocol	Mandatory
File Transfer	Delivery Option	As required
File Transfer	Scanner Resend Interval Time	As required
File Transfer	Number of Scanner Resends	As required

Note

- [IEEE 1394]** is displayed when optional IEEE 1394 interface board is installed.
- As to **[Effective Protocol]**, check if the protocol to use is set as **[Active]**.
- If **[Delivery Option]** is set to **[On]**, check that IPv4 Address is set.

Reference

p.55 "Interface Settings"

p.65 "File Transfer"

IEEE 802.11b (wireless LAN)

This section describes necessary set items for delivering data to network with IEEE 802.11b (wireless LAN).

For details about specifying the settings, see "Interface Settings" and "File Transfer".

Heading	Setting Item	Setting Requirements
Interface Settings/Network	Machine IPv4 Address	Mandatory
Interface Settings/Network	IPv4 Gateway Address	As required
Interface Settings/Network	DNS Configuration	As required
Interface Settings/Network	DDNS Configuration	As required
Interface Settings/Network	Domain Name	As required
Interface Settings/Network	WINS Configuration	As required
Interface Settings/Network	Effective Protocol	Mandatory
Interface Settings/Network	LAN Type	Mandatory
Interface Settings/Network	Permit SNMPv3 Communication	As required
Interface Settings/Network	Permit SSL/TLS Communication	As required
Interface Settings/Network	Host Name	As required
Interface Settings/ IEEE 802.11b	Communication Mode	Mandatory
Interface Settings/ IEEE 802.11b	SSID Setting	As required
Interface Settings/ IEEE 802.11b	Channel	As required
Interface Settings/ IEEE 802.11b	Security Method	As required
Interface Settings/ IEEE 802.11b	Transmission Speed	As required
File Transfer	Delivery Option	As required
File Transfer	Scanner Resend Interval Time	As required
File Transfer	Number of Scanner Resends	As required

Note

- As to **[Effective Protocol]**, check if the protocol to use is set as **[Active]**.
- [IEEE 802.11b]** and **[LAN Type]** are displayed when optional wireless LAN interface board is installed. When both Ethernet and wireless LAN (IEEE 802.11b) are connected, the selected interface takes precedence.
- If **[Delivery Option]** is set to **[On]**, check that IPv4 Address is set.

Reference

p.55 "Interface Settings"

p.65 "File Transfer"

Settings Required to Use Network TWAIN Scanner

This section describes necessary set items for using TWAIN Scanner under the network environment.

Ethernet

This section describes necessary set items for using network TWAIN Scanner with Ethernet cable.

For details about specifying the settings, see "Interface Settings" and "File Transfer".

Heading	Setting Item	Setting Requirements
Interface Settings/Network	Machine IPv4 Address	Mandatory
Interface Settings/Network	IPv4 Gateway Address	As required
Interface Settings/Network	DNS Configuration	As required
Interface Settings/Network	DDNS Configuration	As required
Interface Settings/Network	Domain Name	As required
Interface Settings/Network	WINS Configuration	As required
Interface Settings/Network	Effective Protocol	Mandatory
Interface Settings/Network	LAN Type	Mandatory
Interface Settings/Network	Ethernet Speed	As required
Interface Settings/Network	Permit SNMPv3 Communication	As required
Interface Settings/Network	Permit SSL/TLS Communication	As required
Interface Settings/Network	Host Name	As required

Note

- As to **[Effective Protocol]**, check if the protocol to use is set as **[Active]**.
- [LAN Type]** is displayed when optional wireless LAN interface board is installed. When both Ethernet and wireless LAN (IEEE 802.11b) are connected, the selected interface takes precedence.

Reference

p.55 "Interface Settings"

p.65 "File Transfer"

IEEE 1394 (IPv4 over 1394)

This section describes necessary set items for using network TWAIN Scanner with IEEE 1394 interface cable.

For details about specifying the settings, see "Interface Settings" and "File Transfer".

Heading	Setting Item	Setting Requirements
Interface Settings/IEEE 1394	IPv4 Address	Mandatory
Interface Settings/IEEE 1394	DDNS Configuration	As required
Interface Settings/IEEE 1394	Host Name	As required
Interface Settings/IEEE 1394	Domain Name	As required
Interface Settings/IEEE 1394	WINS Configuration	As required
Interface Settings/IEEE 1394	IPv4 over 1394	Mandatory
Interface Settings/Network	IPv4 Gateway Address	As required
Interface Settings/Network	DNS Configuration	As required
Interface Settings/Network	Effective Protocol	Mandatory

Note

- [IEEE 1394]** is displayed when optional IEEE 1394 interface board is installed.
- As to **[Effective Protocol]**, check if the protocol to use is set as **[Active]**.

Reference

- p.55 "Interface Settings"
- p.65 "File Transfer"

IEEE 802.11b (wireless LAN)

This section describes necessary set items for using network TWAIN Scanner with IEEE 802.11b (wireless LAN).

For details about specifying the settings, see "Interface Settings" and "File Transfer".

Heading	Setting Item	Setting Requirements
Interface Settings/Network	Machine IPv4 Address	Mandatory
Interface Settings/Network	IPv4 Gateway Address	As required
Interface Settings/Network	DNS Configuration	As required
Interface Settings/Network	DDNS Configuration	As required
Interface Settings/Network	Domain Name	As required
Interface Settings/Network	WINS Configuration	As required
Interface Settings/Network	Effective Protocol	Mandatory
Interface Settings/Network	LAN Type	Mandatory
Interface Settings/Network	Permit SNMPv3 Communication	As required
Interface Settings/Network	Permit SSL/TLS Communication	As required
Interface Settings/Network	Host Name	As required
Interface Settings/ IEEE 802.11b	Communication Mode	Mandatory
Interface Settings/ IEEE 802.11b	SSID Setting	As required
Interface Settings/ IEEE 802.11b	Channel	As required
Interface Settings/ IEEE 802.11b	Security Method	As required
Interface Settings/ IEEE 802.11b	Transmission Speed	As required

Note

- As to **[Effective Protocol]**, check if the protocol to use is set as **[Active]**.
- [IEEE 802.11b]** and **[LAN Type]** are displayed when optional wireless LAN interface board is installed. When both Ethernet and wireless LAN (IEEE 802.11b) are connected, the selected interface takes precedence.

Reference

p.55 "Interface Settings"

p.65 "File Transfer"

Settings Required to Use Document Server

This section describes necessary set items for using Document Server function under the network environment.

Ethernet

This section describes necessary set items for using Document Server function with Ethernet cable.

For details about specifying the settings, see "Interface Settings" and "File Transfer".

Heading	Setting Item	Setting Requirements
Interface Settings/Network	Machine IPv4 Address	Mandatory
Interface Settings/Network	IPv4 Gateway Address	As required
Interface Settings/Network	DNS Configuration	As required
Interface Settings/Network	DDNS Configuration	As required
Interface Settings/Network	Domain Name	As required
Interface Settings/Network	WINS Configuration	As required
Interface Settings/Network	Effective Protocol	Mandatory
Interface Settings/Network	Ethernet Speed	As required
Interface Settings/Network	LAN Type	Mandatory
Interface Settings/Network	Permit SNMPv3 Communication	As required
Interface Settings/Network	Permit SSL/TLS Communication	As required
Interface Settings/Network	Host Name	As required

Note

- As to **[Effective Protocol]**, check if the protocol to use is set as **[Active]**.
- [LAN Type]** is displayed when optional wireless LAN interface board is installed. When both Ethernet and wireless LAN (IEEE 802.11b) are connected, the selected interface takes precedence.

Reference

p.55 "Interface Settings"

p.65 "File Transfer"

IEEE 1394 (IPv4 over 1394)

This section describes necessary set items for using Document Server function with IEEE 1394 interface cable.

For details about specifying the settings, see "Interface Settings" and "File Transfer".

Heading	Setting Item	Setting Requirements
Interface Settings/IEEE 1394	IPv4 Address	Mandatory
Interface Settings/IEEE 1394	DDNS Configuration	As required
Interface Settings/IEEE 1394	Host Name	As required
Interface Settings/IEEE 1394	Domain Name	As required
Interface Settings/IEEE 1394	WINS Configuration	As required
Interface Settings/IEEE 1394	IPv4 over 1394	Mandatory
Interface Settings/Network	IPv4 Gateway Address	As required
Interface Settings/Network	DNS Configuration	As required
Interface Settings/Network	Effective Protocol	Mandatory

Note

- [IEEE 1394] is displayed when optional IEEE 1394 interface board is installed.
- As to [Effective Protocol], check if the protocol to use is set as [Active].

Reference

- p.55 "Interface Settings"
- p.65 "File Transfer"

IEEE 802.11b (wireless LAN)

This section describes necessary set items for using Document Server function with IEEE 802.11b (wireless LAN).

For details about specifying the settings, see "Interface Settings" and "File Transfer".

Heading	Setting Item	Setting Requirements
Interface Settings/Network	Machine IPv4 Address	Mandatory
Interface Settings/Network	IPv4 Gateway Address	As required
Interface Settings/Network	DNS Configuration	As required
Interface Settings/Network	DDNS Configuration	As required
Interface Settings/Network	Domain Name	As required
Interface Settings/Network	WINS Configuration	As required
Interface Settings/Network	Effective Protocol	Mandatory
Interface Settings/Network	LAN Type	As required/Mandatory
Interface Settings/Network	Permit SNMPv3 Communication	As required
Interface Settings/Network	Permit SSL/TLS Communication	As required
Interface Settings/Network	Host Name	As required
Interface Settings/ IEEE 802.11b	Communication Mode	Mandatory
Interface Settings/ IEEE 802.11b	SSID Setting	As required
Interface Settings/ IEEE 802.11b	Channel	As required
Interface Settings/ IEEE 802.11b	Security Method	As required
Interface Settings/ IEEE 802.11b	Transmission Speed	As required

Note

- As to **[Effective Protocol]**, check if the protocol to use is set as **[Active]**.
- [IEEE 802.11b]** and **[LAN Type]** are displayed when optional wireless LAN interface board is installed. When both Ethernet and wireless LAN (IEEE 802.11b) are connected, the selected interface takes precedence.

Reference

p.55 "Interface Settings"

p.65 "File Transfer"

Using Utilities to Make Settings

The network settings can be specified not only on the machine's control panel but also using utilities such as Web Image Monitor, SmartDeviceMonitor for Admin, and telnet.

Note

- For details about using Web Image Monitor, see "Using Web Image Monitor", Network Guide.
- For details about using SmartDeviceMonitor for Admin, see "Using SmartDeviceMonitor for Admin", Network Guide.
- For Details about using telnet, see "Remote Maintenance", Network Guide.

Reference

"Using Web Image Monitor" Network Guide

"Using SmartDeviceMonitor for Admin" Network Guide

"Remote Maintenance by telnet" Network Guide

Interface Settings

Change set values of **[Interface Settings]** in **[System Settings]** of this machine by using Web Image Monitor, SmartDeviceMonitor for Admin, and telnet.

- ❖ **[Network] → [Machine IPv4 Address] → [Auto-Obtain (DHCP)]**
 - Web Image Monitor:Can be used for specifying the setting.
 - SmartDeviceMonitor for Admin:Can be used for specifying the setting.
 - telnet:Can be used for specifying the setting.
- ❖ **[Network] → [Machine IPv4 Address] → [Specify] → [IPv4 Address]**
 - Web Image Monitor:Can be used for specifying the setting.
 - SmartDeviceMonitor for Admin:Can be used for specifying the setting.
 - telnet:Can be used for specifying the setting.
- ❖ **[Network] → [Machine IPv4 Address] → [Specify] → [Sub-net Mask]**
 - Web Image Monitor:Can be used for specifying the setting.
 - SmartDeviceMonitor for Admin:Can be used for specifying the setting.
 - telnet:Can be used for specifying the setting.
- ❖ **[Network] → [IPv4 Gateway Address]**
 - Web Image Monitor:Can be used for specifying the setting.
 - SmartDeviceMonitor for Admin:Can be used for specifying the setting.
 - telnet:Can be used for specifying the setting.

- ❖ **[Network] → [Machine IPv6 Address] → [Manual Configuration Address]**
 - Web Image Monitor:Can be used for specifying the setting.
 - SmartDeviceMonitor for Admin:Cannot be used for specifying the setting.
 - telnet:Can be used for specifying the setting.
- ❖ **[Network] → [IPv6 Stateless Address Autoconfiguration]**
 - Web Image Monitor:Can be used for specifying the setting.
 - SmartDeviceMonitor for Admin:Cannot be used for specifying the setting.
 - telnet:Can be used for specifying the setting.
- ❖ **[Network] → [DNS Configuration] → [Auto-Obtain (DHCP)]**
 - Web Image Monitor:Can be used for specifying the setting.
 - SmartDeviceMonitor for Admin:Cannot be used for specifying the setting.
 - telnet:Can be used for specifying the setting.
- ❖ **[Network] → [DNS Configuration] → [Specify] → [DNS Server 1] - [DNS Server 3]**
 - Web Image Monitor:Can be used for specifying the setting.
 - SmartDeviceMonitor for Admin:Cannot be used for specifying the setting.
 - telnet:Can be used for specifying the setting.
- ❖ **[Network] → [DDNS Configuration]**
 - Web Image Monitor:Can be used for specifying the setting.
 - SmartDeviceMonitor for Admin:Cannot be used for specifying the setting.
 - telnet:Can be used for specifying the setting.
- ❖ **[Network] → [Domain Name] → [Auto-Obtain (DHCP)]**
 - Web Image Monitor:Can be used for specifying the setting.
 - SmartDeviceMonitor for Admin:Cannot be used for specifying the setting.
 - telnet:Can be used for specifying the setting.
- ❖ **[Network] → [Domain Name] → [Specify] → [Domain Name]**
 - Web Image Monitor:Can be used for specifying the setting.
 - SmartDeviceMonitor for Admin:Cannot be used for specifying the setting.
 - telnet:Can be used for specifying the setting.
- ❖ **[Network] → [WINS Configuration] → [Primary WINS Server] / [Secondary WINS Server]**
 - Web Image Monitor:Can be used for specifying the setting.
 - SmartDeviceMonitor for Admin:Cannot be used for specifying the setting.
 - telnet:Can be used for specifying the setting.

- ❖ **[Network] → [WINS Configuration] → [Scope ID]**
 - Web Image Monitor: Can be used for specifying the setting.
 - SmartDeviceMonitor for Admin: Cannot be used for specifying the setting.
 - telnet: Can be used for specifying the setting.
- ❖ **[Network] → [Effective Protocol] → [IPv4]**
 - Web Image Monitor: Can be used for specifying the setting.
 - SmartDeviceMonitor for Admin: You can make the TCP/IP settings if SmartDeviceMonitor for Admin is communicating with the machine using IPX/SPX.
 - telnet: Can be used for specifying the setting.
- ❖ **[Network] → [Effective Protocol] → [IPv6]**
 - Web Image Monitor: Can be used for specifying the setting.
 - SmartDeviceMonitor for Admin: Can be used for specifying the setting.
 - telnet: Can be used for specifying the setting.
- ❖ **[Network] → [Effective Protocol] → [NetWare]**
 - Web Image Monitor: Can be used for specifying the setting.
 - SmartDeviceMonitor for Admin: You can make the IPX/SPX settings if SmartDeviceMonitor for Admin is communicating with the machine using TCP/IP.
 - telnet: Can be used for specifying the setting.
- ❖ **[Network] → [Effective Protocol] → [SMB]**
 - Web Image Monitor: Can be used for specifying the setting.
 - SmartDeviceMonitor for Admin: Can be used for specifying the setting.
 - telnet: Can be used for specifying the setting.
- ❖ **[Network] → [Effective Protocol] → [AppleTalk]**
 - Web Image Monitor: Can be used for specifying the setting.
 - SmartDeviceMonitor for Admin: Can be used for specifying the setting.
 - telnet: Can be used for specifying the setting.
- ❖ **[Network] → [NCP Delivery Protocol]**
 - Web Image Monitor: Can be used for specifying the setting.
 - SmartDeviceMonitor for Admin: Can be used for specifying the setting.
 - telnet: Cannot be used for specifying the setting.
- ❖ **[Network] → [NW Frame Type] → [Auto Select]**
 - Web Image Monitor: Can be used for specifying the setting.
 - SmartDeviceMonitor for Admin: Cannot be used for specifying the setting.
 - telnet: Can be used for specifying the setting.

❖ **[Network] → [NW Frame Type] → [Ethernet II]**

- Web Image Monitor:Can be used for specifying the setting.
- SmartDeviceMonitor for Admin:Cannot be used for specifying the setting.
- telnet:Can be used for specifying the setting.

❖ **[Network] → [NW Frame Type] → [Ethernet 802.2]**

- Web Image Monitor:Can be used for specifying the setting.
- SmartDeviceMonitor for Admin:Cannot be used for specifying the setting.
- telnet:Can be used for specifying the setting.

❖ **[Network] → [NW Frame Type] → [Ethernet 802.3]**

- Web Image Monitor:Can be used for specifying the setting.
- SmartDeviceMonitor for Admin:Cannot be used for specifying the setting.
- telnet:Can be used for specifying the setting.

❖ **[Network] → [NW Frame Type] → [Ethernet SNAP]**

- Web Image Monitor:Can be used for specifying the setting.
- SmartDeviceMonitor for Admin:Cannot be used for specifying the setting.
- telnet:Can be used for specifying the setting.

❖ **[Network] → [SMB Computer Name]**

- Web Image Monitor:Can be used for specifying the setting.
- SmartDeviceMonitor for Admin:Cannot be used for specifying the setting.
- telnet:Can be used for specifying the setting.

❖ **[Network] → [SMB Work Group]**

- Web Image Monitor:Can be used for specifying the setting.
- SmartDeviceMonitor for Admin:Cannot be used for specifying the setting.
- telnet:Can be used for specifying the setting.

❖ **[Network] → [Ethernet Speed]**

- Web Image Monitor:Cannot be used for specifying the setting.
- SmartDeviceMonitor for Admin:Cannot be used for specifying the setting.
- telnet:Cannot be used for specifying the setting.

❖ **[Network] → [LAN Type] → [Ethernet]**

- Web Image Monitor:Can be used for specifying the setting.
- SmartDeviceMonitor for Admin:Cannot be used for specifying the setting.
- telnet:Can be used for specifying the setting.

- ❖ **[Network] → [LAN Type] → [IEEE 802.11b]**
 - Web Image Monitor:Can be used for specifying the setting.
 - SmartDeviceMonitor for Admin:Cannot be used for specifying the setting.
 - telnet:Can be used for specifying the setting.
- ❖ **[Network] → [Host Name]**
 - Web Image Monitor:Can be used for specifying the setting.
 - SmartDeviceMonitor for Admin:Can be used for specifying the setting.
 - telnet:Can be used for specifying the setting.
- ❖ **[Network] → [Machine Name]**
 - Web Image Monitor:Can be used for specifying the setting.
 - SmartDeviceMonitor for Admin:Cannot be used for specifying the setting.
 - telnet:Can be used for specifying the setting.
- ❖ **[IEEE 1394] → [IPv4 Address] → [Auto-Obtain (DHCP)]**
 - Web Image Monitor:Can be used for specifying the setting.
 - SmartDeviceMonitor for Admin:Cannot be used for specifying the setting.
 - telnet:Can be used for specifying the setting.
- ❖ **[IEEE 1394] → [IPv4 Address] → [Specify] → [Machine IPv4 Address]**
 - Web Image Monitor:Can be used for specifying the setting.
 - SmartDeviceMonitor for Admin:Cannot be used for specifying the setting.
 - telnet:Can be used for specifying the setting.
- ❖ **[IEEE 1394] → [IPv4 Address] → [Specify] → [Sub-net Mask]**
 - Web Image Monitor:Can be used for specifying the setting.
 - SmartDeviceMonitor for Admin:Cannot be used for specifying the setting.
 - telnet:Can be used for specifying the setting.
- ❖ **[IEEE 1394] → [DDNS Configuration]**
 - Web Image Monitor:Can be used for specifying the setting.
 - SmartDeviceMonitor for Admin:Cannot be used for specifying the setting.
 - telnet:Can be used for specifying the setting.
- ❖ **[IEEE 1394] → [IPv4 over 1394]**
 - Web Image Monitor:Can be used for specifying the setting.
 - SmartDeviceMonitor for Admin:Cannot be used for specifying the setting.
 - telnet:Can be used for specifying the setting.

❖ **[IEEE 1394] → [WINS Configuration] → [Primary WINS Server] / [Secondary WINS Server]**

- Web Image Monitor:Can be used for specifying the setting.
- SmartDeviceMonitor for Admin:Cannot be used for specifying the setting.
- telnet:Can be used for specifying the setting.

❖ **[IEEE 1394] → [WINS Configuration] → [Scope ID]**

- Web Image Monitor:Can be used for specifying the setting.
- SmartDeviceMonitor for Admin:Cannot be used for specifying the setting.
- telnet:Can be used for specifying the setting.

❖ **[IEEE 1394] → [Host Name]**

- Web Image Monitor:Can be used for specifying the setting.
- SmartDeviceMonitor for Admin:Cannot be used for specifying the setting.
- telnet:Can be used for specifying the setting.

❖ **[IEEE 1394] → [Domain Name]**

- Web Image Monitor:Can be used for specifying the setting.
- SmartDeviceMonitor for Admin:Cannot be used for specifying the setting.
- telnet:Can be used for specifying the setting.

❖ **[IEEE 802.11b] → [Communication Mode]**

- Web Image Monitor:Can be used for specifying the setting.
- SmartDeviceMonitor for Admin:Cannot be used for specifying the setting.
- telnet:Can be used for specifying the setting.

❖ **[IEEE 802.11b] → [SSID Setting]**

- Web Image Monitor:Can be used for specifying the setting.
- SmartDeviceMonitor for Admin:Cannot be used for specifying the setting.
- telnet:Can be used for specifying the setting.

❖ **[IEEE 802.11b] → [Channel]**

- Web Image Monitor:Can be used for specifying the setting.
- SmartDeviceMonitor for Admin:Cannot be used for specifying the setting.
- telnet:Can be used for specifying the setting.

❖ **[IEEE 802.11b] → [Security Method]**

- Web Image Monitor:Can be used for specifying the setting.
- SmartDeviceMonitor for Admin:Cannot be used for specifying the setting.
- telnet:Can be used for specifying the setting.

❖ [IEEE 802.11b] → [Transmission Speed]

- Web Image Monitor:Cannot be used for specifying the setting.
- SmartDeviceMonitor for Admin:Cannot be used for specifying the setting.
- telnet:Can be used for specifying the setting.

❖ [File Transfer] → [SMTP Server]

- Web Image Monitor:Can be used for specifying the setting.
- SmartDeviceMonitor for Admin:Cannot be used for specifying the setting.
- telnet:Cannot be used for specifying the setting.

❖ [File Transfer] → [SMTP Authentication]

- Web Image Monitor:Can be used for specifying the setting.
- SmartDeviceMonitor for Admin:Cannot be used for specifying the setting.
- telnet:Cannot be used for specifying the setting.

❖ [File Transfer] → [POP before SMTP]

- Web Image Monitor:Can be used for specifying the setting.
- SmartDeviceMonitor for Admin:Cannot be used for specifying the setting.
- telnet:Cannot be used for specifying the setting.

❖ [File Transfer] → [Reception Protocol]

- Web Image Monitor:Can be used for specifying the setting.
- SmartDeviceMonitor for Admin:Cannot be used for specifying the setting.
- telnet:Cannot be used for specifying the setting.

❖ [File Transfer] → [POP3 / IMAP4 Settings]

- Web Image Monitor:Can be used for specifying the setting.
- SmartDeviceMonitor for Admin:Cannot be used for specifying the setting.
- telnet:Cannot be used for specifying the setting.

❖ [File Transfer] → [Administrator's E-mail Address]

- Web Image Monitor:Can be used for specifying the setting.
- SmartDeviceMonitor for Admin:Cannot be used for specifying the setting.
- telnet:Cannot be used for specifying the setting.

❖ [File Transfer] → [E-mail Communication Port]

- Web Image Monitor:Can be used for specifying the setting.
- SmartDeviceMonitor for Admin:Cannot be used for specifying the setting.
- telnet:Cannot be used for specifying the setting.

❖ **[File Transfer] → [E-mail Reception Interval]**

- Web Image Monitor:Can be used for specifying the setting.
- SmartDeviceMonitor for Admin:Cannot be used for specifying the setting.
- telnet:Cannot be used for specifying the setting.

❖ **[File Transfer] → [Max. Reception E-mail Size]**

- Web Image Monitor:Can be used for specifying the setting.
- SmartDeviceMonitor for Admin:Cannot be used for specifying the setting.
- telnet:Cannot be used for specifying the setting.

❖ **[File Transfer] → [E-mail Storage in Server]**

- Web Image Monitor:Can be used for specifying the setting.
- SmartDeviceMonitor for Admin:Cannot be used for specifying the setting.
- telnet:Cannot be used for specifying the setting.

❖ **[File Transfer] → [Default User Name / Password (Send)]**

- Web Image Monitor:Can be used for specifying the setting.
- SmartDeviceMonitor for Admin:Cannot be used for specifying the setting.
- telnet:Cannot be used for specifying the setting.

❖ **[File Transfer] → [Scanner Resend Interval Time]**

- Web Image Monitor:Cannot be used for specifying the setting.
- SmartDeviceMonitor for Admin:Cannot be used for specifying the setting.
- telnet:Cannot be used for specifying the setting.

❖ **[File Transfer] → [Number of Scanner Resends]**

- Web Image Monitor:Cannot be used for specifying the setting.
- SmartDeviceMonitor for Admin:Cannot be used for specifying the setting.
- telnet:Cannot be used for specifying the setting.

2. System Settings

This chapter describes various items of **[System Settings]** available in this machine.

General Features

This section describes various items of **[General Features]** under **[System Settings]**. Default settings are shown in **bold type**.

❖ Program / Change / Delete User Text

You can register character strings you use frequently when specifying settings, such as ".com" and "Regards".

You can register up to 40 items.

- Program / Change

- ① Press **[System Settings]**.
- ② Check that **[General Features]** is selected.
- ③ Press **[Program / Change / Delete User Text]**.
- ④ Press **[Program / Change]**
- ⑤ Select the user text you want to change.
To program new user text, press **[Not Programmed]**.
- ⑥ Press **[OK]**.
- ⑦ Press **[Exit]**.

- Delete

- ① Press **[System Settings]**.
- ② Check that **[General Features]** is selected.
- ③ Press **[Program / Change / Delete User Text]**.
- ④ Press **[Delete]**.
- ⑤ Select the user text you want to delete.
- ⑥ Press **[Yes]**.
- ⑦ Press **[Exit]**.

❖ Panel Key Sound

The beeper (key tone) sounds when a key is pressed.

- On
- Off

❖ Warm-up Beeper (copier/Document Server)

You can have the beeper sound when the machine becomes ready to copy after leaving Energy Saver mode, or when the power is turned on.

- On
- Off

❖ Copy Count Display (copier/Document Server)

The copy counter can be set to show the number of copies made (count up) or the number of copies yet to be made (count down).

- Up
- Down

❖ Function Priority

You can specify the mode to be displayed immediately after the operation switch is turned on, or when System Reset mode is turned on.

- Copier
- Document Server
- Printer
- Scanner

❖ Print Priority

Print Priority is given to the mode selected.

- Display Mode
- Copier/Document Server
- Printer
- Interleave
- Job Order

When **[Interleave]** is selected, the current print job will be interrupted after a maximum of five sheets.

❖ Function Reset Timer

You can set the length of time the machine waits before changing modes when using the multi-access function.

This is useful if you are making many copies and have to change settings for each copy. If you set a longer reset period, you can prevent interruption from other functions.

The default time is "3 second(s)".

- Set Time
- Immediate

When you select **[Set Time]**, enter the time (3–30 seconds, in 1 second increments) using the number keys.

❖ Interleave Print

Set the number of sheets to be output at the time of operation by interruption. The machine is shipped from the factory with this value set to "10 sheets".

❖ **Output: Copier (copier)**

You can specify a tray to which documents are delivered.

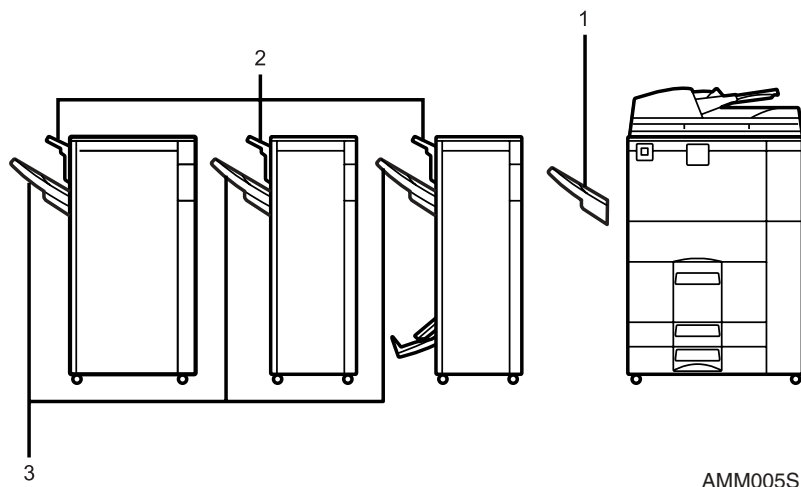
**1. Copy Tray****2. Finisher Upper Tray****3. Finisher Shift Tray**❖ **Output: Document Server (Document Server)**

You can specify a tray to which documents are delivered.

- Copy Tray
- Finisher Upper Tray
- Finisher Shift Tray

❖ **Output: Printer (printer)**

You can specify a tray to which documents are delivered.

The output trays set on the printer driver have priority over the output tray specified below.

- Copy Tray
- Finisher Upper Tray
- Finisher Shift Tray

❖ **ADF Original Table Elevation**

Set when to raise the ADF plate after placing originals on the Auto Document Feeder (ADF).

- **When Original is Set**
- When **[Start]** is Pressed

❖ System Status/Job List Display Time

You can specify how long to display the System Status and Job List display for.

- **On: 15 second(s)**
- Off

By selecting **[On]**, you can specify a display time between 10 and 999 seconds.

❖ Key Repeat

You can enable or disable repetition of an operation if a key on the screen or control panel is pressed continuously.

- Off
- **Normal**
- Repeat Time: Medium
- Repeat Time: Long

❖ Z-fold position

If you specify Z-folding, set the fold-back position in 1 mm (0.1") increments. The setting ranges of the folding position for each paper size are shown below:

- Metric version:
 - A3: 2 - 25 mm
 - B4 JIS: 2 - 40 mm
 - A4: 2 - 10 mm
 - 11 × 17: 2 - 20 mm
 - 8¹/₂ × 14: 2-35 mm

Default: **2 mm**

- Inch version:
 - A3: 0.1" - 1.0"
 - B4 JIS: 0.1" - 1.6"
 - A4: 0.1" - 0.4"
 - 11 × 17: 0.1" - 0.8"
 - 8¹/₂ × 14: 0.1" - 1.4"

Default: **0.1"**

Note

- If the Panel Key Sound setting is **[Off]**, the beeper does not sound, whatever the Warm-up Beeper setting.
- The Function Reset Timer setting is ignored if Interleave is set for Print Priority.

Reference

p.3 "Accessing User Tools (System Settings)"

"Function Compatibility", Copy/Document Server Reference

Output tray settings

Important

- You cannot interrupt the current stapling job even if a stapling job is specified by a different function.
- If Staple or Shift Sort is selected on a machine equipped with Booklet Finisher, 3,000Sheet-100Sheet Staple Finisher, or 3,000Sheet-50Sheet Staple Finisher, copies are output to "Finisher Upper Tray", "Finisher Shift Tray", or "Finisher Booklet Tray", regardless of the current output destination setting.

Tray Paper Settings

This section describes various items of [Tray Paper Settings] under [System Settings].

Default settings are shown in **bold type**.

2

❖ Paper Tray Priority: Copier (copier/Document Server)

You can specify the tray to supply paper for output.

- **Tray 1**
- Tray 2
- Tray 3

❖ Paper Tray Priority: Printer (printer)

You can specify the tray to supply paper for output.

- **Tray 1**
- Tray 2
- Tray 3

❖ Tray Paper Size: Tray 2, Tray Paper Size: Tray 3

Select the size of the paper loaded in the paper tray.

The paper sizes you can set for tray 2/3 are as follows:

"Auto Detect", "A3", "A4", "A4", "A5", "A5", "B4 JIS", "B5 JIS", "B5 JIS", "11×17", "11×15", "11×14", "10×15", "8¹/₂×14", "8¹/₂×13", "8¹/₂×11", "8¹/₂×11", "8¹/₄×14", "8¹/₄×13", "8×13", "8×10¹/₂", "7¹/₄×10¹/₂", "5¹/₂×8¹/₂", "5¹/₂×8¹/₂", "8K", "16K", "16K"

You can specify a custom size of between 139.7-297.0mm (5.5"-11.7") vertically, and between 139.7-432.0mm (5.5"-17.0") horizontally.

❖ Printer Bypass Paper Size

You can specify the size of the paper in the bypass tray when printing data from the computer.

The paper sizes you can set for bypass tray are as follows:

"Auto Detect", "A3", "A4", "A4", "A5", "A5", "A6", "B4 JIS", "B5 JIS", "B5 JIS", "B6 JIS", "11×17", "11×15", "11×14", "10×15", "10×14", "8¹/₂×14", "8¹/₂×13", "8¹/₂×11", "8¹/₂×11", "8¹/₄×14", "8¹/₄×13", "8×13", "8×10¹/₂", "8×10¹/₂", "8×10", "8×10", "7¹/₄×10¹/₂", "7¹/₄×10¹/₂", "5¹/₂×8¹/₂", "Custom Size"

You can specify a custom size of between 100.0-305.0mm (3.9"-12.0") vertically, and between 139.7-600.0mm (5.5"-23.6") horizontally.

If 3,000Sheet-100Sheet Staple Finisher is installed, paper of the following dimensions can be loaded onto the bypass tray: between 100.0-305.0 mm (3.9"-12.0") vertically, and between 139.7 - 458 mm (5.5"-18.1") horizontally.

❖ Paper Type: Bypass Tray

Sets the display so you can see what type of paper is loaded in the bypass tray.

- **No Display**
- Recycled Paper
- Preprinted Paper
- Special Paper
- Thick Paper
- Prepunched Paper
- Colour Paper 1
- Colour Paper 2
- Bond Paper
- Translucent Paper
- Letterhead
- Card Stock
- OHP (Transparency)
- Label Paper

❖ Paper Type: Tray 1

Sets the display so you can see what type of paper is loaded in each paper tray. The print function use this information to automatically select the paper tray.

- Paper Type
 - **No Display**
 - Recycled Paper
 - Preprinted Paper
 - Special Paper
 - Thick Paper
 - Prepunched Paper
 - Colour Paper 1
 - Colour Paper 2
 - Bond Paper
 - Translucent Paper
 - Letterhead
- Copying Method in Duplex
 - **2 Sided Copy**
 - 1 Sided Copy
- Apply Auto Paper Select
 - **Yes**
 - No

❖ Paper Type: Tray 2, Paper Type: Tray 3

Sets the display so you can see what type of paper is loaded in each paper tray. The print function use this information to automatically select the paper tray.

- Paper Type
 - **No Display**
 - Recycled Paper
 - Preprinted Paper
 - Special Paper
 - Thick Paper
 - Prepunched Paper
 - Colour Paper 1
 - Colour Paper 2
 - Bond Paper
 - Translucent Paper
 - Letterhead
 - Tab Stock
 - Index Paper
- Copying Method in Duplex
 - **2 Sided Copy**
 - 1 Sided Copy
- Apply Auto Paper Select
 - **Yes**
 - No

❖ Front Cover Sheet Tray

Allows you to specify and display the paper tray that is setting cover sheets. After selecting the paper tray, you can also specify the display timing and copy method for two-sided copying.

- Tray to Program
 - Bypass Tray
 - Tray 1
 - Tray 2
 - Tray 3
 - Large Capacity Tray
 - Interposer
- Copying Method in Duplex
 - 2 Sided Copy
 - 1 Sided Copy
- Display Time
 - At Mode Selected
 - Full Time

❖ Back Cover Sheet Tray

Specify which paper tray you want to load the back covers from, and make sure confirmation of your setting is displayed. When you have selected the tray, specify the confirmation timing and the copy method for two-sided copying.

- Tray to Program
 - Bypass Tray
 - Tray 1
 - Tray 2
 - Tray 3
 - Large Capacity Tray
 - Interposer
- Copying Method in Duplex
 - 2 Sided Copy
 - 1 Sided Copy
- Display Time
 - At Mode Selected
 - Full Time

❖ Slip Sheet Tray

Specify which paper tray you want to load the insertion sheets from, and make sure confirmation of your setting is displayed. When you have selected the tray, specify the confirmation timing.



- Tray to Program
 - Bypass Tray
 - Tray 1
 - Tray 2
 - Tray 3
 - Large Capacity Tray
- Copying Method in Duplex
 - 2 Sided Copy
 - 1 Sided Copy
- Display Time
 - At Mode Selected
 - Full Time

❖ Designation Sheet 1 Tray, Designation Sheet 2 Tray

Specify which paper tray you want to load the chapter division sheets from, and make sure confirmation of your setting is displayed. When you have selected the tray, specify the confirmation timing and the copy method for two-sided copying.

- Tray to Program
 - Bypass Tray
 - Tray 1
 - Tray 2
 - Tray 3
 - Large Capacity Tray
 - Interposer
- Copying Method in Duplex
 - 2 Sided Copy
 - 1 Sided Copy
- Display Time
 - At Mode Selected
 - Full Time

 **Note**

- ❑ The paper guide for the LCT is fixed for A4 , 8 1/2"×11"  size paper. Contact your service representative if you need to change the paper size.
- ❑ When paper of the same type and size is loaded in two different paper trays and you want to specify tray for 2 Sided Copy. If one of the trays is specified as the default in Paper Tray Priority, assign 2 Sided Copy to that tray.
- ❑ A  mark appears next to the paper tray if **[Off]** is selected in **[Apply Auto Paper Select]**.
- ❑ **[Apply Auto Paper Select]** can only be selected for the copier function if **[No Display]** and **[Recycled Paper]** are selected. If **[No]** is selected, Apply Auto Paper Select is not valid for the tray.
- ❑ Functions using the front cover sheet tray setting are the front cover function and front/back cover function.
- ❑ The function for using "Setting of tray for chapter division paper 1" or "Setting of tray for chapter division paper 2" is the specified paper insertion function.
- ❑ If you set "Display Time" to "At Mode Selected" in "Front Cover Sheet Tray" and "Slip Sheet Tray", the trays selected for the cover sheets and slip sheets are indicated only if you have enabled the use of cover sheets and slip sheets.

 **Reference**

p.3 "Accessing User Tools (System Settings)"

"Copying onto Tab Stock", Copy/ Document Server Reference

"Covers", Copy/ Document Server Reference

"Slip Sheets", Copy/ Document Server Reference

"Blank Slip Sheets", Copy/ Document Server Reference

Timer Settings

This section describes various items of [Timer Settings] under [System Settings].

Default settings are shown in **bold type**.

❖ Auto Off Timer

After a specified period has passed, following job completion, the machine automatically turns off, in order to conserve energy. This function is called "Auto Off". The machine status after the Auto Off operation is referred to as "Off mode", or "Sleep mode". For the Auto Off Timer, specify the time to elapse before Auto Off.

The timing is set to "**1 min.**" by default.

The time can be set from 10 seconds to 240 minutes, using the number keys.

Auto Off may not work when error messages appear.

❖ Energy Saver Timer

Set the amount of time the machine waits before switching to lower-power mode after copying has finished or the last operation is performed.

The time can be set from 1 to 240 minutes, using the number keys.

The timing is set to "**1 min.**" by default.

❖ Panel Off Timer

Set the amount of time the machine waits before switching the panel off after copying has finished or the last operation is performed.

The warm up time for making a copy from standby mode is 3 seconds for Panel off Level 1 and 15 seconds for Panel off Level 2.

- **On**
- **Off**

The time can be set from 10 seconds to 240 minutes, using the number keys.

The timing is set to "**1 min.**" by default.

❖ System Auto Reset Timer

The System Reset setting automatically switches the screen to that of the function set in Function Priority when no operations are in progress, or when an interrupted job is cleared. This setting determines the system reset interval.

- **On**
- **Off**

The time can be set from 10 to 999 seconds, using the number keys

The timing is set to "**60 second(s)**" by default.

❖ Copier / Document Server Auto Reset Timer (copier/Document Server)

Specifies the time to elapse before copier and Document Server modes reset.

- On
- Off

If **[Off]** is selected, the machine does not automatically switch to the user code entry screen.

The time can be set from 10 to 999 seconds, using the number keys.

The timing is set to "**60 second(s)**" by default.

❖ Printer Auto Reset Timer (printer)

Specifies the time to elapse before the printer function resets.

- On
- Off

The time can be set from 10 to 999 seconds, using the number keys.

The timing is set to "**60 second(s)**" by default.

❖ Scanner Auto Reset Timer (scanner)

Specifies the time to elapse before the scanner function resets.

- On
- Off

If **[Off]** is selected, the machine will not automatically switch to the user code entry screen.

The time can be set from 10 to 999 seconds, using the number keys.

The timing is set to "**60 second(s)**" by default.

❖ Set Date

Set the date for the copier's internal clock using the number keys.

To change between year, month, and day, press **[←]** and **[→]**.

❖ Set Time

Set the time for the copier's internal clock using the number keys.

Enter the time using the 24-hour format (in 1 second increments).

To change between hours, minutes and seconds, press **[←]** and **[→]**.

❖ Auto Logout Timer

You can specify whether or not to automatically log out a user when the user does not operate the machine for a specified period of time after logging in.

- On
- Off

When **[On]** is selected, the time can be set from 60 to 999 seconds, in one second increments, using the number keys.

The timing is set to "**180 second(s)**" by default.

❖ **Weekly Timer Code**

Set a password (using not more than eight digits) for turning on the power during the time periods when "Weekly Timer" turns off the machine's power.

- On
- **Off**

If you have selected "On", enter the password. When you select "on", you cannot use the machine even if you turn the power switch to "On", unless you enter the password. If you select "Off", you do not have to enter a password to switch on the machine, you need only turn the power switch to "On".

❖ **Weekly Timer: Monday - Sunday**

Set the daily time when the power is switched on/off.

- Power On Time
- Power Off Time

Enter the time using the 24-hour system.

Enter the "hour" and "minute" using the number keys.

Reference

p.3 "Accessing User Tools (System Settings)"

Interface Settings

This section describes various items of **[Interface Settings]** under **[System Settings]**. Default settings are shown in **bold type**.

Reference

p.3 “Accessing User Tools (System Settings)”

2

Network

This section describes various items of **[Network]** under **[Interface Settings]**.

❖ Machine IPv4 Address

Before using this machine in the network environment, you must configure the IP address and subnet mask.

When you select **[Specify]**, enter the **[Machine IPv4 Address]** and **[Sub-net Mask]** as "xxx.xxx.xxx.xxx" ("x" indicates a number).

If you install the optional IEEE 1394 interface board and use the IEEE 1394 interface, you must set the address of the domain, different from the **[IPv4 Address]** of **[IEEE 1394]**. If you intend to set the address for the same domain, set a different value for the **[Sub-net Mask]**.

When you select **[Specify]**, be sure not to set the same **[Machine IPv4 Address]** as that of another machines on the network.

The physical address (MAC Address) also appears.

If you use the interface for Ethernet and IEEE 1394 (IP over 1394) at the same time, settings must be made carefully.

- **Auto-Obtain (DHCP)**
- Specify
 - Machine IPv4 Address: 011.022.033.044
 - Sub-net Mask: 000.000.000.000

❖ IPv4 Gateway Address

A gateway is a connection or interchange point between two networks. Configure the gateway address for the router or host computer used as a gateway.

- **IPv4 Gateway Address: 000.000.000.000**

❖ Machine IPv6 Address

You can specify the machine's IPv6 network address.

- Link-local Address
The machine's specified link-local address appears.
- Manual Configuration Address
The machine's manually configuration address appears.
- Stateless Address: 1-5
The specified stateless address appears.

❖ **IPv6 Gateway Address**

The machine's IPv6 gateway address appears.

❖ **IPv6 Stateless Address Autoconfiguration**

You can set "IPv6 Stateless Address Autoconfiguration" to "Active" or "Inactive".

- Active
- Inactive

❖ **DNS Configuration**

Make settings for the DNS server.

When you select **[Specify]**, enter the **[DNS Server 1] - [DNS Server 3]** IP address as "xxx.xxx.xxx.xxx" ("x" indicates a number).

- **Auto-Obtain (DHCP)**
- Specify
 - DNS Server 1: 000.000.000.000
 - DNS Server 2: 000.000.000.000
 - DNS Server 3: 000.000.000.000

❖ **DDNS Configuration**

You can specify the DDNS settings.

- Active
- Inactive

❖ **Domain Name**

You can specify the domain name.

- **Auto-Obtain (DHCP)**
- Specify

Enter the domain name using not more than 63 single-byte alphanumeric characters.

❖ **WINS Configuration**

You can specify the WINS server settings.

If **[On]** is selected, enter the WINS Server IPv4 address as "xxx.xxx.xxx.xxx" ("x" indicates a number).

If DHCP is in use, specify the **[Scope ID]**.

Enter a **[Scope ID]** using up to 31 alphanumeric characters.

- On
 - Primary WINS Server: 000.000.000.000
 - Secondary WINS Server: 000.000.000.000
 - Scope ID
- Off

❖ Effective Protocol

Select the protocol to use in the network.

- IPv4: **Active** / Inactive
- IPv6: Active / **Inactive**
- NetWare: **Active** / Inactive
- SMB: **Active** / Inactive
- AppleTalk: **Active** / Inactive

❖ NCP Delivery Protocol

Select the protocol for NCP delivery.

- IPX Priority
- **TCP / IP Priority**
- IPX Only
- TCP / IP Only

❖ NW Frame Type

Select the frame type when you use NetWare.

- **Auto Select**
- Ethernet II
- Ethernet 802.2
- Ethernet 802.3
- Ethernet SNAP

❖ SMB Computer Name

Specify the SMB computer name.

Enter the computer name using up to 15 alphanumerical characters.

"*+/,/;<>=?[\]|. and spaces cannot be entered.

Setting a computer name starting with RNP and rnp is inhibited.

Use uppercase letters for alphabet.

❖ SMB Work Group

Specify the SMB work group.

Enter the computer name using up to 15 alphanumerical characters.

"*+/,/;<>=?[\]|. and spaces cannot be entered.

Use uppercase letters for alphabet.

❖ Ethernet Speed

Set the access speed for networks.

Select a speed that matches your network environment. **[Auto Select]** should usually be selected.

- **Auto Select**
- 10Mbps Full Duplex
- 10Mbps Half Duplex
- 100Mbps Full Duplex
- 100Mbps Half Duplex

❖ LAN Type

When you have installed the optional IEEE 802.11b interface unit, select interface, IEEE 802.11b (wireless LAN) or Ethernet.

- **Ethernet**
- IEEE 802.11b

Appears when the IEEE 802.11b interface unit is installed.

If Ethernet and IEEE 802.11b (wireless LAN) are both connected to the machine, the selected interface takes precedence.

❖ Ping Command

Check the network connection with ping command using given IPv4 address. If you fail to connect to the network, check the following, and then retry the ping command.

- Check TCP/IP of the printer is active.
- Check that the machine with assigned IPv4 address is connected to the network.
- There is a possibility that same IPv4 address is used for the specified equipment.

❖ Permit SNMPv3 Communication

Set the encrypted communication of SNMPv3.

- Encryption Only
- **Encryption / Clear Text**

If you set to **[Encryption Only]**, you need to set password for the machine.

❖ Permit SSL / TLS Communication

Set the encrypted communication of SSL/TLS.

- Ciphertext Only
- **Ciphertext Priority**
- Ciphertext / Clear Text

If you set to **[Ciphertext Only]**, you need to install the server authentication for the machine.

❖ Host Name

Specify the host name.

Enter the host name using up to 63 alphanumeric characters.

❖ Machine Name

Specify the machine name.

Enter the machine name using up to 31 alphanumeric characters.

Parallel Interface

This section describes various items of **[Parallel Interface]** under **[Interface Settings]**.

[Parallel Interface] is displayed when this machine is installed with the IEEE 1284 interface board (optional).

2

❖ Parallel Timing

Sets the timing for the control signal of the parallel interface.

- **ACK Outside**
- ACK Inside
- STB Down

❖ Parallel Communication Speed

Sets the communication speed for the parallel interface.

- **High Speed**
- Standard

❖ Selection Signal Status

Sets the level for the select signal of the parallel interface.

- **High**
- Low

❖ Input Prime

Sets whether to validate or invalidate the input prime signal upon receipt.

- **Active**
- Inactive

❖ Bidirectional Communication

Sets the printer's response mode to a status acquisition request when using a parallel interface.

- **On**
- Off

When set to **[Off]**, bidirectional communication function will be disabled. Also, printer driver will not be installed under Windows Auto Detect function.

❖ Signal Control

Sets procedure to error during printing.

- **Job Acceptance Priority**
- Printer Priority

IEEE 1394

This section describes various items of **[IEEE 1394]** under **[Interface Settings]**.

[IEEE 1394] is displayed when this machine is installed with the IEEE 1394 interface board.

❖ IPv4 Address

When you connect the machine to a network using the IEEE 1394 interface, you must configure the IP address and subnet mask.

When you select **[Specify]**, enter the **[Machine IPv4 Address]** and **[Sub-net Mask]** as "xxx.xxx.xxx.xxx" ("x" indicates a number).

When you use the IEEE 1394 interface on a network, you cannot use the Ethernet interface in the same domain. To use both interfaces in the same domain, set different values for the **[Sub-net Mask]**.

If you use the interface for Ethernet and IEEE 1394 (IP over 1394) at the same time, settings must be made carefully.

- **Auto-Obtain (DHCP)**
- Specify
 - Machine IPv4 Address: 011.022.033.044
 - Sub-net Mask: 000.000.000.000

❖ DDNS Configuration

You can specify the DDNS settings.

- **Active**
- **Inactive**

❖ Host Name

Specify the host name.

Enter the host name using up to 63 alphanumerical characters.

❖ Domain Name

Make settings for the domain name.

- **Auto-Obtain (DHCP)**
- Specify
 - Enter the domain name using up to 63 alphanumerical characters.

❖ WINS Configuration

You can specify the WINS server settings.

If **[On]** is selected, specify the WINS Server IPv4 address as “xxx.xxx.xxx.xxx” (“xxx” indicates a number).

If DHCP is in use, specify the **[Scope ID]**.

Enter **[Scope ID]** using up to 31 alphanumeric characters.

- On
 - Primary WINS Server: 000.000.000.000
 - Secondary WINS Server: 000.000.000.000
 - Scope ID
- Off

❖ IPv4 over 1394

When you use the IPv4 over 1394 function of the IEEE 1394 interface to connect the machine to the network, or you print from computer with the IPv4 over 1394 driver, you must specify **[Active]** for **[IPv4 over 1394]**.

- Active
- Inactive

Printing with IPv4 over 1394 is possible under Windows Me/XP and Windows Server 2003.

❖ SCSI print (SBP-2)

When you print using the SCSI print client function supported by Windows 2000/XP, or Windows Server 2003, you must set **[SCSI print (SBP-2)]**.

- Active
- Inactive

❖ Bidirectional SCSI print

Specifies the printer's response mode etc. for status requests when using the IEEE 1394 interface.

- On
- Off

If this is set to **[Off]** bidirectional communication will not work.

IEEE 802.11b

This section describes various items of **[IEEE 802.11b]** under **[Interface Settings]**.

[IEEE 802.11b] is displayed when this machine is installed with the wireless LAN interface board (optional).

Implement respective settings simultaneously.

2

❖ **Communication Mode**

Be sure to make all settings simultaneously.

- 802.11 adhoc
- adhoc
- **Infrastructure Mode**

❖ **SSID Setting**

Specifies SSID to distinguish the access point in infrastructure mode or 802.11 adhoc mode.

The characters that can be used are ASCII 0x20-0x7e (32 bytes).

If blank is specified in 802.11b adhoc mode or adhoc mode, "ASSID" appears.

❖ **Channel**

Specifies a channel when you select 802.11b adhoc mode or adhoc mode.

The channel is set to "11" by default.

The following channels are available:

- Metric version: 1-14
- Inch version: 1-11

❖ **Security Method**

Specifies the encryption of the IEEE 802.11b (wireless LAN).

If set to **[WEP]**, always enter WEP key. If set to **[WPA]**, set encryption method and authentication method.

You can specify "WPA", if you set **[Communication Mode]** to **[Infrastructure Mode]**.

- **Off**
- WEP
 - WEP (Encryption) key
Enter the WEP (Encryption) key. If it is a 64-bit WEP (Encryption) key, enter 10 hexadecimal digits or 5 ASCII code characters. For a 128-bit WEP (Encryption) key, enter 26 hexadecimal digits or 13 ASCII code characters.
- WPA
 - WPA Encryption Method
Select either "TKIP" or "CCMP(AES)".
 - WPA Authent. Method
Select either "WPA-PSK" or "WPA802.1X)". If you have selected "WPA-PSK", enter the pre-shared key (PSK) of 8- 63 characters in ASCII code.

❖ Wireless LAN Signal

Shows the radio wave conditions of the access point connected in infrastructure mode.

Radio wave status is displayed when you press **[Wireless LAN Signal]**.

❖ Transmission Speed

Specifies the communication speed of the IEEE 802.11b (wireless LAN).

- **Auto Select**
- 11Mbps Fixed
- 5.5Mbps Fixed
- 2Mbps Fixed
- 1Mbps Fixed

❖ Restore Factory Defaults

You can return the IEEE 802.11b (wireless LAN) settings to their defaults.

- No
- Yes

Print List

You can check items related to the network in use.

The configuration page shows the current network settings and network information.

2

1 Press [System Settings].

2 Press [Interface Settings].

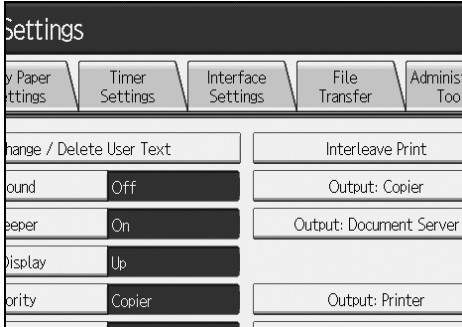

3 Press [Print List].

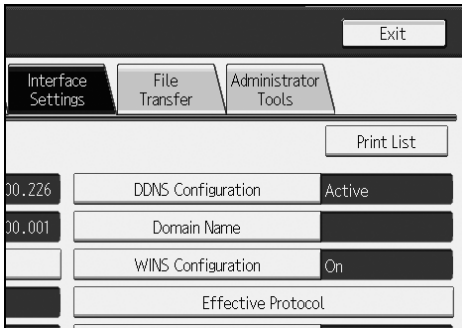

4 Press the [Start] key.

The configuration page is printed.

5 Press [Exit].

6 Press the [User Tools/Counter] key.

 **Note**

You can also exit by pressing [Exit] on the User Tools main menu.

File Transfer

This section describes various items of **[File Transfer]** under **[System Settings]**. Default settings are shown in **bold type**.

❖ Delivery Option

Enables or disables sending stored or scanned documents to ScanRouter V2 delivery server.

- On
 - Main Delivery Server IPv4 Address
 - Sub Delivery Server IPv4 Address

- **Off**

Set this option when specifying whether or not to use ScanRouter V2. If you do, you will have to re-register I/O devices in ScanRouter V2.

❖ Capture Server IPv4 Address

Specify the capture server IPv4 address.

Displayed only when you use the Capture function with ScanRouter V2.

❖ SMTP Server

If DNS is in use, enter the host name.

If DNS is not in use, enter the SMTP server IP address.

- Server Name
- Port No.: 25

Enter the **[Server Name]** using up to 127 alphanumeric characters. Spaces cannot be used.

Enter **[Port No.]** between 1 and 65535 using the number keys, and then press the **[#]** key.

❖ SMTP Authentication

You can configure SMTP authentication (PLAIN, LOGIN, CRAMMD5, DIGEST-MD5).

When sending e-mail to an SMTP server, you can enhance the SMTP server security level by authentication that requires entering the user name and password.

If the SMTP server requires authentication, set **[SMTP Authentication]** to **[On]**, and then specify **[User Name]**, **[Password]**, and **[Encryption]**.

- SMTP Authentication

- On

User Name

Enter **[User Name]** using up to 191 alphanumeric characters. Spaces cannot be used. Depending on the SMTP server type, "realm" must be specified. Add "@" after the user name, as in "user name@realm".

E-mail Address

Password

Enter **[Password]** using up to 63 alphanumeric characters. Spaces cannot be used.

Encryption: **Auto** / On / Off

[Encryption]-[Auto]: If the authentication method is PLAIN, LOGIN, CRAM-MD5, or DIGEST-MD5.

[Encryption]-[On]: If the authentication method is CRAMMD5 or DIGEST-MD5.

[Encryption]-[Off]: If the authentication method is PLAIN, or LOGIN.

- Off

❖ POP before SMTP

You can configure POP authentication (POP before SMTP).

When sending e-mail to an SMTP server, you can enhance the SMTP server security level by connecting to the POP server for authentication.

To enable POP server authentication before sending e-mail via the SMTP server, set **[POP before SMTP]** to **[On]**. E-mail is sent to the SMTP server after the time specified for **[Wait Time after Authent.]** has elapsed.

If you select **[On]**, enter **[Server Name]** in **[POP3 / IMAP4 Settings]**. Also, check the port number for **[POP3]** in **[E-mail Communication Port]**.

- On

- Wait Time after Authent.: **300msec**

Using the number keys, you can set **[Wait Time after Authent.]** from zero to 10,000 milliseconds, in increments of one millisecond.

- User Name

Enter **[User Name]** using up to 63 alphanumeric characters. Spaces cannot be used.

- E-mail Address

- Password

Enter **[Password]** using up to 63 alphanumeric characters. Spaces cannot be used.

- Off

❖ Reception Protocol

Specify Reception Protocol for "Auto E-mail Notification".

For details about the "Auto E-mail Notification" function, see the Web Image Monitor Help.

- **POP3**
- **IMAP4**
- **SMTP**

❖ POP3 / IMAP4 Settings

Specify the POP3/IMAP4 server name for sending or receiving e-mail.

The POP3/IMAP4 server name specified here is used for **[POP before SMTP]**.

- **Server Name**
If DNS is in use, enter the host name.
If DNS is not in use, enter the POP3/IMAP4 or server IPv4 address.
Enter POP3/IMAP4 server name using up to 127 characters. Spaces cannot be entered.
- **Encryption**
 - **Auto**
Password encryption is automatically set according to the POP/IMAP server settings.
 - **On**
Encrypt password.
 - **Off**
Do not encrypt password.

❖ Administrator's E-mail Address

On e-mailed scanned documents, if the sender is not specified this appears as the sender's address.

If you have specified the user name and e-mail address in **[SMTP Authentication]**, make sure to specify this setting.

Enter within up to 128 alphanumeric characters.

On e-mailed scanned documents, if **[Auto Specify Sender Name]** is **[Off]**, specify the sender.

❖ E-mail Communication Port

Specify the port number for sending or receiving e-mail. The POP3 port number specified here is used for **[POP before SMTP]**.

- **POP3: 110**
- **IMAP4: 143**
- **SMTP: 25**

Enter a port number between 1 and 65535 using the number keys, and then press the **【#】** key.

❖ E-mail Reception Interval

Specify, in minutes, the time interval for "Auto E-mail Notification" via POP3 or IMAP4 server.

For details about the "Auto E-mail Notification" function, see the Web Image Monitor Help.

- **On: 15 minute(s)**
- Off

If **[On]** is selected, the time interval can be specified from 2 to 1440 in increments of one minute.

❖ Max. Reception E-mail Size

Specify the maximum reception e-mail size for "Auto E-mail Notification".

For details about the "Auto E-mail Notification" function, see the Web Image Monitor Help.

- **2MB**

Enter a size from 1 to 50 MB in increments of one megabyte.

❖ E-mail Storage in Server

Specify whether or not to store received "Auto E-mail Notification" e-mails on the POP3 or IMAP4 server.

For details about the "Auto E-mail Notification" function, see the Web Image Monitor Help.

- **Off**
- All
- Errors Only

❖ Default User Name / Password (Send)

You can specify the user name and password required when sending scan file directly to a shared folder on a computer running Windows, to an FTP server, or to a NetWare server.

- SMB User Name
- SMB Password
- FTP User Name
- FTP Password
- NCP User Name
- NCP Password

Enter in up to 64 alphanumerical characters.

❖ Program / Change / Delete E-mail Message

You can program, change, or delete the e-mail message used when sending scan file as an attachment.

- Program / Change

- ① Press **[System Settings]**.
- ② Press **[File Transfer]**.
- ③ Press **[▼Next]**.
- ④ Press **[Program / Change / Delete E-mail Message]**.
- ⑤ Press **[Program / Change]**.
- ⑥ Press **[Not Programmed]**.
- ⑦ Press **[Change]**.
- ⑧ Enter a name, and then press **[OK]**.
Enter the name using up to 20 alphanumerical characters.
- ⑨ Press **[Edit]**.
To start a new line, press **[OK]** to return to the e-mail message screen, and then press **[▼]** in "Select Line to Edit:".
- ⑩ Press **[Edit]**.
- ⑪ Enter the text, and then press **[OK]**.
Enter up to five lines of text. Each line can consist of up to 80 alphanumeric characters.
- ⑫ Press **[OK]**.
- ⑬ Press **[Exit]**.

- Delete

- ① Press **[System Settings]**.
- ② Press **[File Transfer]**.
- ③ Press **[▼Next]**.
- ④ Press **[Program / Change / Delete E-mail Message]**.
- ⑤ Press **[Delete]**.
- ⑥ Select the e-mail message to delete.
The confirmation message about deleting appears.
- ⑦ Press **[Yes]**.

❖ Auto Specify Sender Name

Set whether or not to specify the name of the sender when sending e-mail.

- **On**
If you select **[On]**, the specified e-mail address will appear in the "From:" box. If you do not specify the sender's address, the administrator's e-mail address will appear in the "From:" box.
- **Off**
If you select **[Off]**, the specified e-mail address will appear in the "From:" box, but you cannot send e-mail without specifying the sender's e-mail address.

❖ **Scanner Resend Interval Time**

Specifies the interval the machine waits before resending scan file, if they cannot be sent to the delivery server or mail server.

The timing is set to "300 second(s)" by default.

The interval time can be set from 60 to 999 seconds in one second increments, using the number keys.

This setting is for the scanner function.

❖ **Number of Scanner Resends**

Sets a maximum number of times scan file is resent to the delivery server or mail server.

- **On: 3 time(s)**
- Off

If **[On]** is selected, the number of times can be set from 1 to 99 using the number keys. This setting is for the scanner function.

This setting is for the scanner function.

 **Note**

- ☐ For details about using Web Image Monitor, see the Web Image Monitor Help.

 **Reference**

p.3 "Accessing User Tools (System Settings)"

Administrator Tools

This section describes various items of **[Administrator Tools]** under **[System Settings]**.

Default settings are shown in **bold type**.

Administrator Tools are used by the administrator. To change these settings, contact the administrator.

We recommend specifying Administrator Authentication before making Administrator Tools settings.

❖ Address Book Management

You can add, change or delete information registered in the Address Book. For details, see "Address Book".

- Program / Change

You can register and change names as well as user codes.

- Names

You can register a name, key display, registration number, and title selection.

- Auth. Info

You can register a user code, and specify the functions available to each user code. You can also register user names and passwords to be used when sending e-mail, sending files to folders, or accessing an LDAP server.

- Protection

You can register a protection code.

- E-mail

You can register an e-mail address.

- Folder

You can register the SMB, FTP, NCP, Path, Connection Test.

- Add to Group

You can put names registered in the Address Book into a group.

- Delete

You can delete a name from the Address Book.

You can register up to 2,000 names.

You can register up to 500 user codes.

You can also register and manage names in the Address Book using Web Image Monitor or SmartDeviceMonitor for Admin.

Use SmartDeviceMonitor for Admin provided with the printer scanner unit.

❖ **Address Book: Program / Change / Delete Group**

Names registered in the Address Book can be added into a group. You can then easily manage the names registered in each group.

- Program / Change
You can register and change groups.
 - Names
You can register a name, key display, registration number, and title selection.
 - Programmed User/Group
You can check the names or groups registered in each group.
 - Protection
You can register a protection code.
 - Add to Group
You can put groups registered in the Address Book into a group.
- Delete
You can delete a group from the Address Book.

You can register up to 100 groups.

You can also register and manage groups in the Address Book using Web Image Monitor or SmartDeviceMonitor for Admin.

Use SmartDeviceMonitor for Admin provided with the printer scanner unit.

❖ **Address Book: Change Order**

Changes the order of registered name.

You can rearrange the order of items on the same page, but you cannot move items to another page.

For example, you cannot move an item from “PLANNING” ([OPQ]) to “DAILY” ([CD]).

- ① Press [System Settings].
- ② Press [Administrator Tools].
- ③ Press [Address Book: Change Order].

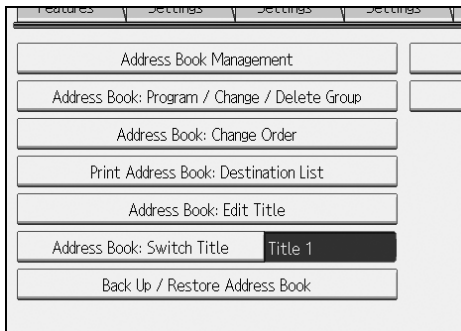

- ④ Press the name key to be move.

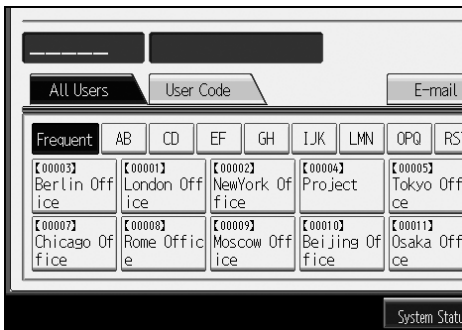

You can select a name using the number keys.

- ⑤ Press the name key in the place you want to move to.



The selected user key is moved to the selected position, and the user key currently at the selected position is moved forward or backward.

If you move the selected user key forward, the user key currently at the selected position is moved backward.

If you move the selected user key backward, the user key currently at the selected position is moved forward.



You can also select a name using the number keys.

❖ **Print Address Book: Destination List**

You can print the destination list registered in the Address Book.

- Print in Title 1 Order
Prints the Address Book in Title 1 order.
- Print in Title 2 Order
Prints the Address Book in Title 2 order.
- Print in Title 3 Order
Prints the Address Book in Title 3 order.
- Print Group Dial List
Prints the group Address Book.

- ① Press **[System Settings]**.
- ② Press **[Administrator Tools]**.
- ③ Press **[Print Address Book: Destination List]**.
- ④ Select the print format.
- ⑤ To print the list on two-sided pages, select **[Print on 2 Sides]**.
- ⑥ Press the **[Start]** key.
The list prints out.

❖ **Address Book: Edit Title**

You can edit the title to easily find a user.

- ① Press **[System Settings]**.
- ② Press **[Administrator Tools]**.
- ③ Press **[Address Book: Edit Title]**.

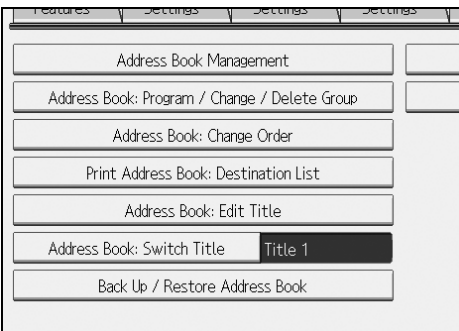

- ④ Press the title key you want to change.

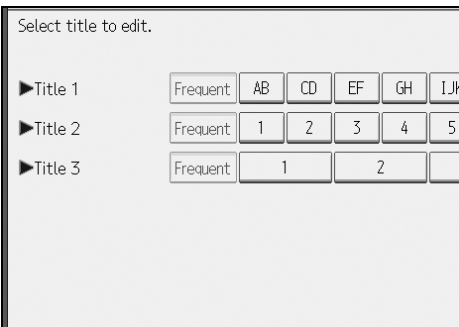

- ⑤ Enter the new name, and then press **[OK]**.
- ⑥ Press **[OK]**.

❖ **Address Book: Switch Title**

Specifies the title to select a name.

- **Title 1**
- Title 2
- Title 3

❖ **Back Up / Restore Address Book**

You can back up the machine's address book to external storage or restore the backup copy from the external storage.

- **Back Up**
You can back up the machine's address book to external storage.
- **Restore**
You can restore the backup copy of the address book from external storage.
- **Format**
You can format the external storage.
- **Obtain Media Info**
The free space and occupied space of the external storage are displayed.

❖ **Display / Print Counter**

Allows you to view and print the number of prints.

- **Display / Print Counter**
Displays the number of prints for each function (Total, Copier, Printer, A3/DLT, Duplex, Transmission total, and Scanner transmission).
- **[Print Counter List]**
Prints out a list of the number of prints made under each function.

❖ **Display / Clear / Print Counter per User**

Allows you to view and print the numbers of prints accessed with user codes, and to set those values to 0.

Press **[▲Previous]** and **[▼Next]** to show all the numbers of prints.

The number of prints may differ from the counter value shown in Display / Print Counter.

- **Print Counter List for All Users**
Prints the counter values for all the users.
- **Clear Counter for All Users**
Sets the counter value for all the users.
- **Print Counter List Per User**
Prints the counter values for each user.
- **Clear Counter Per User**
Sets the counter value for each user.

❖ **User Authentication Management**

- User Code Auth.

Using User Code Authentication, you can limit the available functions and supervise their use.

When using User Code Authentication, register the user code.

Using the Printer PC Control function, you can obtain a log of prints corresponding to the codes entered using the printer driver.

For details about Basic Authentication, Windows Authentication, LDAP Authentication, and Integration Server Authentication, consult your administrator.

Function to Restrict

- Copier
- Document Server
- Printer
- Printer: PC Control
- Scanner

Printer Job Authentication

- Entire
- Simple (Limitation)
- Simple (All)
- Basic Auth.
- Windows Auth.
- LDAP Auth.
- Integration Svr. Auth.
- **Off**

❖ **Enhanced Authentication Management**

For details about this function, consult your administrator.

❖ **Administrator Authentication Management**

For details about this function, consult your administrator.

❖ **Program / Change Administrator**

For details about this function, consult your administrator.

❖ **Key Counter Management**

You can specify that functions that you want to manage with the key counter.

- Copier
- Document Server
- Printer
- Scanner

❖ **Extended Security**

You can specify whether or not to use the extended security functions. For details about the extended security functions, consult your administrator.

❖ **Auto Delete File in Document Server**

You can specify whether documents stored in the Document Server will or will not be deleted after a specified period of time.

- **On: 3 day(s)**
- Off

If you select **[On]**, documents stored subsequently are deleted after the specified period.

If you select **[Off]**, documents are not automatically deleted.

If you select **[On]**, enter a number of days from 1 to 180 (in 1 day increments). The default is 3 days, this means documents are deleted 3 days (72 hours) after they are stored.

❖ **Delete All Files in Document Server**

You can delete files stored in the Document Server, including files stored for Sample Print, Locked Print, Hold Print, and Stored Print under the printer function.

- No
- Yes

Even if a password is always set, all documents are deleted.

A confirmation message appears. To delete all documents, select **[Yes]**.

❖ **Program / Change / Delete LDAP Server**

Program the LDAP server to find up e-mail destinations in the LDAP server Address Book directly. This function is possible when sending scan files by e-mail using the scanner.

- Name
- Server Name
- Search Base
- Port Number
- Use Secure Connection (SSL)
- Authentication
- User Name
- Password
- Search Conditions
- Search Options

To start an LDAP search, make sure that the items listed below are set. For other items, check your environment and make any necessary changes.

- Server Name
- Search Base
- Port Number
- Authentication
- Search Conditions

To use the LDAP server in Administrator Tools, select **[On]** under LDAP server. This function supports LDAP Version 2.0 and 3.0. Ver 2.0 does not support High Security authentication.

❖ **LDAP Search**

You can specify whether or not to use the LDAP server for searching.

- On
- **Off**

If you select **[Off]**, **[LDAP Search]** will not appear on the searching display.

❖ **AOF (Always On)**

Specify whether or not to use Auto Off.

- On
- Off

❖ **Preheating level setting**

Set the level of the preheating mode.

Level	Approximate warm-up time
1	3 sec
2	15 sec

❖ **Firmware Version**

You can check the version of the software installed in this machine.

❖ **Network Security Level**

For details about this function, consult your administrator.

❖ **Auto Erase Memory Setting**

For details about this function, consult your administrator.

❖ **Erase All Memory**

For details about this function, consult your administrator.

❖ **Delete All Logs**

For details about this function, consult your administrator.

❖ **Transfer Log Setting**

For details about this function, consult your administrator.

❖ Data Security for Copying

For details about this function, consult your administrator.

❖ Print Backup: Delete All Files

To delete a print backup document, press **[Yes]**.

❖ Print Backup: Compression

Set the compression method for the document you want to back up.

- **High Compression**
- Normal Compression
- Low Compression

❖ Print Backup: Default Format

Set the default format for the document you want to back up.

- **For Printing**
- JPEG
- TIFF
- PDF (Single Page)
- PDF (Multi-page)

❖ Print Backup: Default Resolution

Set the default resolution for the document you want to back up.

- 100 %
- 66 %
- **50 %**
- 33 %
- 25 %

 Reference

p.3 "Accessing User Tools (System Settings)"

p.159 "Address Book"

p.173 "Printing the Counter for Each User"

p.220 "Counter"

Program / Change / Delete LDAP Server

This section explains how to specify the LDAP server settings.

To program / change the LDAP server

2

- 1** Press [System Settings].
- 2** Press [Administrator Tools], and then press [▼Next] twice.
- 3** Press [Program / Change / Delete LDAP Server].
- 4** Check that [Program / Change] is selected.
- 5** Select the LDAP server you want to program or change.
When programming the server, select [Not Programmed].
- 6** Set each item as necessary.
- 7** Press [OK] after setting each item.
For details about LDAP server, see "Programming the LDAP server".
- 8** Press [Exit].
- 9** Press the [User Tools/Counter] key.

 **Reference**

p.81 "Programming the LDAP server"

To delete the programmed LDAP server

- 1** Press [System Settings].
- 2** Press [Administrator Tools], and then press [▼Next] twice.
- 3** Press [Program / Change / Delete LDAP Server].
- 4** Press [Delete].
- 5** Select the LDAP server you want to delete.
- 6** Press [Yes].
- 7** Press [Exit].
- 8** Press the [User Tools/Counter] key.

Programming the LDAP server

This section explains how to specify the LDAP server settings.

To enter an identification name

- 1** Press [Change] under “Name”.

Register a name for the LDAP server that will appear on the server selection screen of the LDAP search operation.

- 2** Enter the server’s identification name.

- 3** Press [OK].
-

To enter a server name

- 1** Press [Change] under “Server Name”.

Register the LDAP server’s host name or IPv4 address.

- 2** Enter the LDAP server name.

- 3** Press [OK].
-

To enter the search base

- 1** Press [Change] under “Search Base”.

Select a route folder to start the search from e-mail addresses registered in the selected folder are search targets.

- 2** Enter the search base.

For example, if the search target is the sales department of ABC company, enter “dc=sales department, o=ABC”. (In this example, the description is for an active directory. “dc” is for the organization unit, and “o” is for the company.)

Search base registration may be required depending on your server environment. When registration is required, unspecified searches will result in error. Check you server environment and enter any required specifications.

- 3** Press [OK].

To enter a port number

1 Press **[Change]** under “Port No.”.

Specify the port number for communicating with the LDAP server. Specify a port that is compliant with your environment.

2 Enter the port number using the number keys, and then press the **[#]** key.

When SSL is set to **[On]**, the port number automatically changes to “636”.

To start SSL communication

1 Press **[On]**.

Use SSL to communicate with the LDAP server.

To use SSL, the LDAP server must support SSL.

When SSL is set to **[On]**, the port number automatically changes to “689”.

SSL setting must be enabled on this machine. For details, consult your network administrator.

To set authentication

1 Press **[▼Next]**.

2 Press **[On]** or **[High Security]** under “Authentication”.

To make a search request to the LDAP server, use the administrator account for authentication.

Authentication settings must comply with your server’s authentication settings. Check your server settings before setting this machine.

[High Security] is available only with LDAP Version 3.0.

When **[High Security]** is selected, the administrator password is encrypted before it is sent to the network. When **[On]** is selected, the password is sent without encryption.

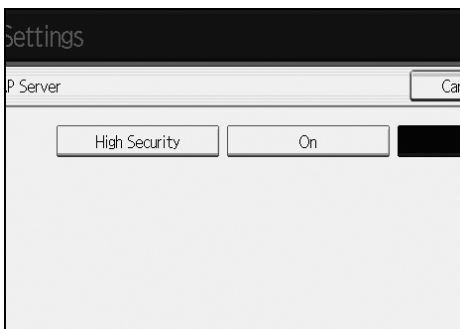

To enter the user name and password

1 Press **[Change]** under “User Name”.

When **[On]** or **[High Security]** is selected for the authentication setting, use the administrator account name and password. Do not enter the administrator account name and password when using authentication for each individual or each search.

2 Enter the user name, and then press **[OK]**.

Procedures for the user name setting differ depending on server environment. Check your server environment before making the setting.

Example: Domain Name\User Name, User Name@Domain Name, CN=Name, OU=Department Name, DC=Server Name

3 Press **[Change]** under “Password”.

4 Enter the password, and then press **[OK]**.

The user name and password are required for administrator authentication to access the LDAP server.

You can set the user name and password in this machine’s Address Book to allow individual authentication access to the LDAP server. Use Administrator Tools to select the user name and password you want to use.

To test the connection

1 Press **[Connection Test]**.

Access the LDAP server to check the proper connection is established. Check authentication works according to the authentication settings.

A connection test is carried out.

2 Press **[Exit]**.

If the connection test fails, check your settings and try again.

This function does not check search conditions or the search base.

To set search conditions

1 Press [▼Next] twice.

2 Press [Change] for items you want to use as search conditions from the following: [Name], [E-mail Address], [Company Name], and [Department Name].

You can enter an attribute as a typical search keyword. Using the entered attribute, the function searches the LDAP server's Address Book.

3 Enter the attribute you want to use when searching for e-mail addresses, and then press [OK].

The attribute value may change depending on the server environment. Check the attribute value complies with your server environment before setting it.

You can leave items blank, but you cannot leave attributes blank when searching for e-mail addresses from the LDAP server Address Book.

To set search options

1 Press [▼Next] three times.

2 Press [Change] under "Attribute".

3 Enter the attribute you want to use when searching for e-mail addresses, and then press [OK].

To search the LDAP server data using a keyword other than prepared keywords such as Name, E-mail Address, FAX Number, Company Name, and Department Name, specify the attribute for the keyword registered in your LDAP server, and the name to be displayed on the control panel during the search. For example, to search e-mail addresses by employee number, enter "employeeNo." in the Attribute field, and "Employee No." in the key display field.

The attribute value may change depending on the server environment. Check the attribute complies with your server environment before setting it.

4 Press [Change] under "Key Display".

5 Enter the key display, and then press [OK].

The registered "key display" appears as a keyword for searching LDAP.

- Without key display registration

Name	Beginning Word	End Word	Exact Match
E-mail Address	Beginning Word	End Word	Exact Match
Company Name	Beginning Word	End Word	Exact Match
Department Name	Beginning Word	End Word	Exact Match

- With key display registration

Name	Beginning Word	End Word	Exact Match
E-mail Address	Beginning Word	End Word	Exact Match
Company Name	Beginning Word	End Word	Exact Match
Department Name	Beginning Word	End Word	Exact Match
Employee No.	Beginning Word	End Word	Exact Match

The key does not appear on the search screen unless both "Attribute" and "Key Display" are registered. Make sure you register both to use the optional search.

System Settings on Main and Sub-machines

This section explains the System Settings on the two machines during Connect Copy.

When connect copy is in progress, the **[User Tools/Counter]** keys of the sub-machines remain disabled. To change the default settings, first press **[Connect Copy]**, which is highlighted on main machine's control screen, then clear the connect copy job, and then make the required changes.

2

General Features

How the defaults in the General Features of copying of the main and sub-machines are used in connect copy will be explained.

❖ Program / Change / Delete User Text

- The main machine applies the setting that has been made on it. Sub-machines also apply their own respective settings.

❖ Panel Key Sound

- The main machine applies the setting that has been made on it. Sub-machines also apply their own respective settings.

❖ Warm-up Beeper

- The main machine applies the setting that has been made on it. Sub-machines also apply their own respective settings.

❖ Copy Count Display

- Settings made on the main and sub-machines do not affect the connect copy.
- The copy counter is always displayed as Up (count up).

❖ Function Priority

- Settings made on the main and sub-machines do not affect the connect copy.
- When the Auto Reset time of the main machine has lapsed, Connect Copy will be cancelled. After that, the machine switches back to the mode selected in Function Priority upon reaching the System Reset time.

❖ Print Priority

- Settings made on the main and sub-machines do not affect the connect copy.
- When the Auto Reset time of the main machine has lapsed, Connect Copy will be cancelled. After that, the machine switches back to the mode selected in Function Priority upon reaching the System Reset time.

❖ Function Reset Timer

- Settings made on the main and sub-machines do not affect the connect copy.

❖ Interleave Print

- Settings made on the main and sub-machines do not affect the connect copy.

❖ Output: Copier

- The main machine applies the setting that has been made on it. Sub-machines also apply their own respective settings.

❖ Output: Document Server

- The main machine applies the setting that has been made on it. Sub-machines also apply their own respective settings.

❖ Output: Printer

- The main machine applies the setting that has been made on it. Sub-machines also apply their own respective settings.

❖ ADF Original Table Elevation

- The main machine applies the setting that has been made on it. Sub-machine settings do not affect connect copy.

❖ System Status/Job List Display Time

- The main machine applies the setting that has been made on it. Sub-machines also apply their own respective settings.

❖ Key Repeat

- The main machine applies the setting that has been made on it. Sub-machines also apply their own respective settings.

❖ Z-fold Position

- The main machine applies the setting that has been made on it. Sub-machines also apply their own respective settings.
- Make the same settings on both machines.

Tray Paper Settings

How the defaults in the Tray Paper Settings of copying of the main and sub-machines are used in connect copy will be explained.

❖ Paper Tray Priority: Copier

- The main machine applies the setting that has been made on it. Sub-machines also apply their own respective settings.

❖ Paper Tray Priority: Printer

- The main machine applies the setting that has been made on it. Sub-machines also apply their own respective settings.

❖ Tray Paper Size: Tray 2, Tray Paper Size: Tray 3

- The main machine applies the setting that has been made on it. Sub-machines also apply their own respective settings.
- Both the main and sub-machines should have the same paper tray settings. Only paper trays with the same size, orientation and paper type of paper can be used in Connect Copy mode.

❖ Printer Bypass Paper Size

- The main machine applies the setting that has been made on it. Sub-machines also apply their own respective settings.

❖ Paper Type: Bypass tray

- The bypass tray can only be used with the Covers and Chapter functions.

❖ Paper Type: Tray 1

- The main machine applies the setting that has been made on it. Sub-machines also apply their own respective settings.
- Paper size, orientation, and type settings that match those currently made on both the main and sub-machines can be used for connect copy. To get the most from the connect copy function, we recommend you make the same paper settings on both the main and sub-machines.

❖ Paper Type: Tray 2, Paper Type: Tray 3

- The main machine applies the setting that has been made on it. Sub-machines also apply their own respective settings.
- Paper size, orientation, and type settings that match those currently made on both the main and sub-machines can be used for connect copy. To get the most from the connect copy function, we recommend you make the same paper settings on both the main and sub-machines.

❖ Front Cover Sheet Tray

- The main machine applies the setting that has been made on it. Sub-machines also apply their own respective settings.

❖ Back Cover Sheet Tray

- The main machine applies the setting that has been made on it. Sub-machines also apply their own respective settings.

❖ Slip Sheet Tray

- The main machine applies the setting that has been made on it. Sub-machines also apply their own respective settings.

❖ Destination Sheet 1 Tray, Destination Sheet 2 Tray

- The main machine applies the setting that has been made on it. Sub-machines also apply their own respective settings.

Timer Settings

How the defaults in the Timer Settings of copying of the main and sub-machines are used in connect copy will be explained.

❖ Auto Off Timer

- The main machine applies the setting that has been made on it. Sub-machine settings do not affect connect copy.

❖ Energy Saver Timer

- Settings made on the main and sub-machines do not affect the connect copy.
- In Connect Copy mode, neither machine will enter Energy Saver modes (Low Power mode, or Energy Saver mode).

❖ Panel Off Timer

- Settings made on the main and sub-machines do not affect the connect copy.
- In Connect Copy mode, neither machine will enter Energy Saver modes (Low Power mode, or Energy Saver mode).

❖ System Auto Reset Timer

- Settings made on the main machine do not affect connect copy. Only sub-machines can be used for interruption copying.
- When the System Reset time has lapsed, Interrupt mode on the sub-machine will be cancelled.

❖ Copier / Document Server Auto Reset Timer

- Settings made on the main and sub-machines do not affect the connect copy.

❖ Printer Auto Reset Timer

- Settings made on the main and sub-machines do not affect the connect copy.

❖ **Scanner Auto Reset Timer**

- Settings made on the main and sub-machines do not affect the connect copy.

❖ **Set Date**

- The main machine applies the setting that has been made on it. Sub-machines also apply their own respective settings.

❖ **Set Time**

- The main machine applies the setting that has been made on it. Sub-machines also apply their own respective settings.

❖ **Auto Logout Timer**

- Settings made on the main and sub-machines do not affect the connect copy.

❖ **Weekly Timer Code**

- Settings made on the main and sub-machines do not affect the connect copy.

❖ **Weekly Timer: Monday - Sunday**

- The main machine applies the setting that has been made on it. Sub-machine settings do not affect connect copy.
- In Connect Copy mode, Weekly timer settings on the sub-machine will be disabled.

Administrator Tools

How the defaults in the Administrator Tools of copying of the main and sub-machines are used in connect copy will be explained.

❖ **Address Book Management**

- Settings made on the main and sub-machines do not affect the connect copy.

❖ **Address Book: Program / Change / Delete Group**

- Settings made on the main and sub-machines do not affect the connect copy.

❖ **Address Book: Change Order**

- Settings made on the main and sub-machines do not affect the connect copy.

❖ **Print Address Book: Destination List**

- Settings made on the main and sub-machines do not affect the connect copy.

❖ Address Book: Edit Title

- Settings made on the main and sub-machines do not affect the connect copy.

❖ Address Book: Switch Title

- Settings made on the main and sub-machines do not affect the connect copy.

❖ Back Up / Restore Address Book

- Settings made on the main and sub-machines do not affect the connect copy.

❖ Display / Print Counter

- Settings made on the main and sub-machines do not affect the connect copy.

❖ Display / Clear / Print Counter per User

- Settings made on the main and sub-machines do not affect the connect copy.

❖ User Authentication Management

- The main machine applies the setting that has been made on it. Sub-machine settings do not affect connect copy.

❖ Enhanced Authentication Management

- The main machine applies the setting that has been made on it. Sub-machine settings do not affect connect copy.

❖ Administrator Authentication Management

- The main machine applies the setting that has been made on it. Sub-machine settings do not affect connect copy.

❖ Program / Change Administrator

- The main machine applies the settings that have been made on it. Sub-machines also apply the settings made on the main machine, regardless of the settings made on them.

❖ Key Counter Management

- The main machine applies the settings that have been made on it. Sub-machines also apply the settings made on the main machine, regardless of the settings made on them.

❖ Extended Security

- Settings made on the main and sub-machines do not affect the connect copy.

❖ Auto Delete File in Document Server

- The main machine applies the setting that has been made on it. Sub-machine settings do not affect connect copy.

❖ Delete All Files in Document Server

- The main machine applies the setting that has been made on it. Sub-machine settings do not affect connect copy.

❖ Program / Change / Delete LDAP Server

- Settings made on the main and sub-machines do not affect the connect copy.

❖ LDAP Search

- Settings made on the main and sub-machines do not affect the connect copy.

❖ AOF (Always On)

- Settings made on the main and sub-machines do not affect the connect copy.
- During Connect Copy, neither machine is turned off automatically. The power will be turned off only when you exit from Connect Copy mode.

❖ Preheating level setting

- Settings made on the main and sub-machines do not affect the connect copy.

❖ Firmware Version

- Settings made on the main and sub-machines do not affect the connect copy.

❖ Network Security Level

- Settings made on the main and sub-machines do not affect the connect copy.

❖ Auto Erase Memory Setting

- Settings made on the main and sub-machines do not affect the connect copy.

❖ Erase All Memory

- Settings made on the main and sub-machines do not affect the connect copy.

❖ Delete All Logs

- The main machine applies the setting that has been made on it. Sub-machines also apply their own respective settings.

❖ Transfer Log Setting

- The main machine applies the setting that has been made on it. Sub-machines also apply their own respective settings.

❖ Data Security for Copying

- The main machine applies the setting that has been made on it. Sub-machine settings do not affect connect copy.

❖ Print Backup: Delete All Files

- Settings made on the main and sub-machines do not affect the connect copy.

❖ Print Backup: Compression

- Settings made on the main and sub-machines do not affect the connect copy.

❖ Print Backup: Default Format

- Settings made on the main and sub-machines do not affect the connect copy.

❖ Print Backup: Default Resolution

- Settings made on the main and sub-machines do not affect the connect copy.

3. Copier/Document Server Features

This chapter describes various items of [Copier / Document Server Features] available in this machine.

General Features

This section describes various items of [General Features] under [Copier / Document Server Features].

Default settings are shown in **bold type**.

❖ Auto Image Density Priority

You can set whether Auto Image Density is “On” or “Off” when the machine is turned on, reset, or modes are cleared.

- Text
 - **On**
 - Off
- Text / Photo
 - **On**
 - Off
- Photo
 - On
 - **Off**
- Pale
 - **On**
 - Off
- General Copy
 - **On**
 - Off

❖ Copy Quality

You can adjust the copy quality level for each original type.

- Text
 - Soft
 - **Normal**
 - Sharp
- Text / Photo
 - Photo Priority
 - **Normal**
 - Text Priority

- Photo
 - **Printed Photo**
 - Normal
 - Glossy Photo
- Pale
 - Soft
 - **Normal**
 - Sharp
- General Copy
 - Soft
 - **Normal**
 - Sharp

❖ **Image Density**

You can adjust the image density level for each original type.

- Text
 - Light
 - **Normal**
 - Dark
- Text / Photo
 - Light
 - **Normal**
 - Dark
- Photo
 - Light
 - **Normal**
 - Dark
- Pale
 - Light
 - **Normal**
 - Dark
- General Copy
 - Light
 - **Normal**
 - Dark

❖ Original Orientation in Duplex Mode

You can set the original orientation when making two-sided copies.

- **Top to Top**
- Top to Bottom

❖ Copy Orientation in Duplex Mode

You can set the copy orientation when making two-sided copies.

- **Top to Top**
- Top to Bottom

❖ Max. Copy Quantity

The maximum copy quantity can be set between 1 and 999.

The maximum copy quantity is set to "**999 sheet(s)**" by default.

❖ Auto Tray Switching

If you load paper of the same size in two or more trays, the machine automatically shifts to the other when the first tray runs out of paper (when Apply Auto Paper Select is selected.) This function is called "Auto Tray Switching". This setting specifies whether to use Auto Tray Switching or not.

- **With Image Rotation**
Use to copy when using the Auto Tray Switching function.
- **Without Image Rotation**
Only copies with Auto Tray Switching if you load paper of the same size and in the same orientation in two or more trays. If the paper is not the same size or in the same orientation, copying is interrupted and the message "Load paper." is displayed.
- **Off**
When a paper tray runs out of paper, copying is interrupted and the message "Load paper." is displayed.

❖ Paper Display

You can choose to have the available paper trays and sizes shown on the initial display.

- **Display**
- Hide

❖ Original Type Display

You can have the original types shown on the initial display.

- Hide
- **Display**

❖ **Tone: Original Remains**

The beeper (key tone) sounds if you forget to remove originals after copying.

- On
- Off

If Panel Key Sound of User Tools (System Settings) is **[Off]** the beeper does not sound irrespective of the Tone: Original remains setting.

❖ **Job End Call**

You can choose whether or not the beeper sounds when copying is complete. If Panel Key Sound of User Tools (System Settings) settings is [On], the machine beeps to notify you that it did not complete a job for reasons such as copying was interrupted, the paper tray ran out of paper, or a paper jam occurred.

- On
- Off

❖ **Connect Copy Key Display**

You can specify whether or not to display the key for Connect Copy.

- On
- Off

❖ **Switch Original Counter Display**

You can select the original counter display.

- Original Sheet Counter
- Original Page Counter

❖ **Customize Function : Copier**

You can assign up to six frequently-used functions to Copy Function keys.

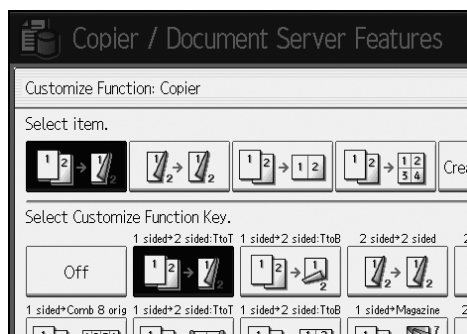

- Off
- 1 Sided → 2 Sided: Top to Top
- 1 Sided → 2 Sided: Top to Bottom
- 2 Sided → 2 Sided
- 2 Sided → 2 sheets
- 1 Sided → 1 Sided Combine: 2 originals
- 1 Sided → 1 Sided Combine: 4 originals

- 1 Sided → 1 Sided Combine: 8 originals
- 1 Sided → 2 Sided: Top to Top
- 1 Sided → 2 Sided: Top to Bottom
- 1 Sided → Magazine
- 2 Sided → Magazine
- Create Margin
- Original Orientation
- Batch
- Staple: Bottom 1
- Punch: 2 Holes Left
- Punch: 2 Holes Top
- Punch: 3 Holes Left
- Punch: 3 Holes Top
- Punch: 4 Holes Left
- Punch: 4 Holes Top
- Right Fold
- Bottom Fold
- Positive / Negative
- 3 Edges Full Bleed
- Face Up

Default:

- F1: 1 Sided → 2 Sided: Top to Top
- F2: 2 Sided → 2 Sided
- F3: 1 Sided → 1 Sided Combine: 2 originals
- F4: 1 Sided → 1 Sided Combine: 4 originals
- F5: Create Margin
- F6: Off

❖ **Customize Function : Document Server Storage**

You can assign up to six frequently-used functions to Document Server Storage keys.

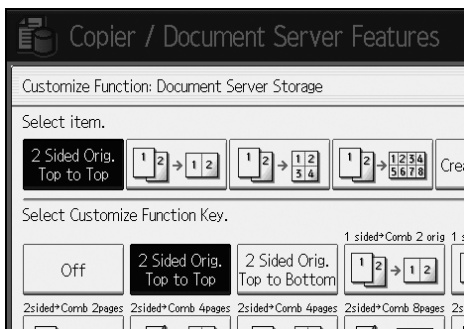

- Off
- 2 Sided original: Top to Top
- 2 Sided original: Top to Bottom
- 1 Sided → 1 Sided Combine: 2 originals
- 1 Sided → 1 Sided Combine: 4 originals
- 1 Sided → 1 Sided Combine: 8 originals
- 2 Sided: Top to Top → 1 Sided Combine: 2 pages
- 2 Sided: Top to Bottom → 1 Sided Combine: 2 pages
- 2 Sided: Top to Top → 1 Sided Combine: 4 pages
- 2 Sided: Top to Bottom → 1 Sided Combine: 4 pages
- 2 Sided: Top to Top → 1 Sided Combine: 8 pages
- 2 Sided: Top to Bottom → 1 Sided Combine: 8 pages
- Create Margin
- Original Orientation
- Batch

❖ Customize Function : Document Server Print

You can assign up to six frequently-used functions to Document Server Print keys.

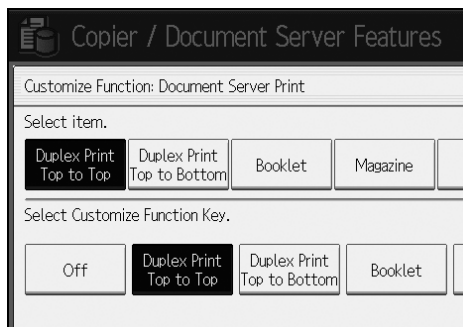

- Off
- Duplex Print Top to Top
- Duplex Print Top to Bottom
- Booklet
- Magazine
- 3 Edges Full Bleed
- Face Up
- Staple: Bottom 1
- Right Fold
- Bottom Fold
- Punch: 2 Holes Left
- Punch: 2 Holes Top
- Punch: 3 Holes Left
- Punch: 3 Holes Top
- Punch: 4 Holes Left
- Punch: 4 Holes Top

🔍 Reference

p.3 "Accessing User Tools (System Settings)"

p.41 "Panel Key Sound"

"Selecting the Original Type Setting", Copy/ Document Server Reference

"Adjusting Copy Image Density", Copy/ Document Server Reference

"Selecting Copy Paper", Copy/ Document Server Reference

Reproduction Ratio

This section describes various items of **[Reproduction Ratio]** under **[Copier / Document Server Features]**.

Default settings are shown in **bold type**.

❖ Shortcut R / E

You can register up to three frequently used Reduce/Enlarge ratios other than the fixed Reduce/Enlarge ratio and have them shown on the initial display. You can also change registered Reduce/ Enlarge ratios.

- Metric version
 - 25%
 - A3 → A5, 8×13 → A5 (50%)
 - A3 → 8×13 (65%)
 - A3 → A4, A4 → A5 (71%)
 - B4 JIS → 8×13 (75%)
 - 8×13 → A4, B4 JIS → 8×13 (82%)
 - 93%
 - B4 JIS → A3 (115%)
 - 8×13 → A3, A4 → B4 JIS (122%)
 - A4 → A3, A5 → A4 (141%)
 - A5 → A3 (200%)
 - 400%
 - User R / E Ratio (25-400%)
 - Off

Default:

- F1: **71%**
- F2: **141%**
- F3: **93%**

- Inch version
 - 25%
 - 11"×17" → 5¹/₂"×8¹/₂" (50%)
 - 11"×17" → 8¹/₂"×11" (65%)
 - 11"×15" → 8¹/₂"×11" (73%)
 - 8¹/₂"×14" → 8¹/₂"×11" (78%)
 - F → 8¹/₂"×11" (85%)
 - 93%
 - 8¹/₂"×14" → 11"×17" (121%)
 - 8¹/₂"×11" → 11"×17" (129%)
 - 8¹/₂"×8¹/₂" → 8¹/₂"×14" (155%)
 - 5¹/₂"×8¹/₂" → 11"×17" (200%)
 - 400%
 - User R / E Ratio (25-400%)
 - Off

Default:

- F1: **73%**
- F2: **155%**
- F3: **93%**

❖ R / E Ratio

You can specify the enlargement and reduction ratios that appear if [**Reduce / Enlarge**] is pressed on the copier screen.

Select key to set the R / E ratio.

115%	122%	141%	200%
B4ns→A3	845→A3 A4→B4ns	A4→A3 A5→A4	A5→A3
25%	50%	65%	71%
A3→A5 845→A5	A3→845	A3→A4 A4→A5	B4ns→845
			82%
			845→A4 B4ns→845

Select the R / E ratio to set selected key.

25%	50%	65%	71%
93%	115%	122%	141%

User R / E Ratio

- Metric version
 - 25%
 - A3 → A5, 8×13 → A5 (50%)
 - A3 → 8×13 (65%)
 - A3 → A4, A4 → A5 (71%)
 - B4 JIS → 8×13 (75%)
 - 8×13 → A4, B4 JIS → 8×13 (82%)
 - 93%
 - B4 JIS → A3 (115%)
 - 8×13 → A3, A4 → B4 JIS (122%)
 - A4 → A3, A5 → A4 (141%)
 - A5 → A3 (200%)
 - 400%
 - User R / E Ratio (25-400%)
- Inch version
 - 25%
 - 11"×17" → 5¹/₂"×8¹/₂" (50%)
 - 11"×17" → 8¹/₂"×11" (65%)
 - 11"×15" → 8¹/₂"×11" (73%)
 - 8¹/₂"×14" → 8¹/₂"×11" (78%)
 - 8¹/₂"×13" → 8¹/₂"×11" (85%)
 - 93%
 - 8¹/₂"×14" → 11"×17" (121%)
 - 8¹/₂"×11" → 11"×17" (129%)
 - 5¹/₂"×8¹/₂" → 8¹/₂"×14" (155%)
 - 5¹/₂"×8¹/₂" → 11"×17" (200%)
 - 400%
 - User R / E Ratio (25-400%)

❖ R / E Ratio Priority

You can set the ratio with priority when **[Reduce / Enlarge]** is pressed.

- Metric version
 - 25%
 - A3 → A5, 8×13 → A5 (50%)
 - A3 → 8×13 (65%)
 - A3 → A4, A4 → A5 (71%)
 - B4 JIS → 8×13 (75%)
 - 8×13 → A4, B4 JIS → 8×13 (82%)
 - 93%
 - B4 JIS → A3 (115%)
 - 8×13 → A3, A4 → B4 JIS (122%)
 - A4 → A3, A5 → A4 (141%)
 - A5 → A3 (200%)
 - 400%
- Inch version
 - 25%
 - 11"×17" → 5¹/₂"×8¹/₂" (50%)
 - 11"×17" → 8¹/₂"×11" (65%)
 - 11"×15" → 8¹/₂"×11" (73%)
 - 8¹/₂"×14" → 8¹/₂"×11" (78%)
 - 8¹/₂"×13" → 8¹/₂"×11" (85%)
 - 93%
 - 8¹/₂"×14" → 11"×17" (121%)
 - 8¹/₂"×11" → 11"×17" (129%)
 - 5¹/₂"×8¹/₂" → 8¹/₂"×14" (155%)
 - 5¹/₂"×8¹/₂" → 11"×17" (200%)
 - 400%

❖ Ratio for Create Margin

You can set a Reduce/Enlarge ratio when registering Create Margin in a shortcut key.

Enter a ratio using number keys (in the range of 90 to 99%).

The ratio is set to "93%" by default.

Reference

p.3 "Accessing User Tools (System Settings)"

Edit

This section describes various items of **[Edit]** under **[Copier / Document Server Features]**.

Default settings are shown in **bold type**.

Enter the width of the binding margin with the number keys as follows:

- Metric version: 0–30 mm (in increments of 1 mm)
- Inch version: 0"-1.2" (in increments of 0.1 inch)

Enter the width of the erased margin with the number keys as follows:

- Metric version: 2–99 mm (in increments of 1 mm)
- Inch version: 0.1"-3.9" (in increments of 0.1 inch)

An image of approximately 1.5 mm (0.06") will not be displayed as the width of the separation line, when specifying solid or broken lines.

❖ **Front Margin: Left / Right**

You can specify left and right margins on the front side of copies in Margin Adjustment mode.

- **Left**
- **Right**

Default:

- Metric version: **Left 5 mm**
- Inch version: **Left 0.2"**

❖ **Back Margin: Left / Right**

You can specify left and right margins on the back side of copies in Margin Adjustment mode.

- **Left**
- **Right**

Default:

- Metric version: **Right 5 mm**
- Inch version: **Right 0.2"**

❖ **Front Margin: Top / Bottom**

You can specify top and bottom margins on the front side of copies in Margin Adjustment mode.

- **Top**
- **Btm.**

Default:

- Metric version: **Top / Bottom 0mm**
- Inch version: **Top / Bottom 0.0"**

❖ **Back Margin: Top / Bottom**

You can specify top and bottom margins on the back side of copies in Margin Adjustment mode.

- **Top**
- **Btm.**

Default:

- Metric version: **Top / Bottom 0mm**
- Inch version: **Top / Bottom 0.0"**

❖ **1 Sided → 2 Sided Auto Margin: TtoT**

In 1 sided to 2 sided Duplex mode, you can specify the margins on the back side. The margin is set to the same value of "Back Margin: Left / Right".

- **Left**
- **Right**

Default:

- Metric version: **Right 5 mm**
- Inch version: **Right 0.2"**

❖ **1 Sided → 2 Sided Auto Margin: TtoB**

In 1 sided to 2 sided Duplex mode, you can specify the margins on the back side. The value set for "Back Margin: Top / Bottom" is used.

- **Top**
- **Btm.**

Default:

- Metric version: **Top / Bottom 0mm**
- Inch version: **Top / Bottom 0.0"**

❖ **Erase Border Width**

You can specify the width of the erased border margins with this function.

Default:

- Metric version: **10mm**
- Inch version: **0.4"**

❖ **Erase Original Shadow in Combine**

In Combine mode, you can specify whether to erase a 3 mm, 0.1" boundary margin around all four edges of each original.

- **On**
- **Off**

❖ **Erase Centre Width**

You can specify the width of the erased centre margins with this function.

Default:

- Metric version: **10 mm**
- Inch version: **0.4"**

❖ **Front Cover Copy in Combine**

You can make a combined copy on the front cover sheet when you select Front Cover mode.

Combine				Not Combined				
1	2	5	6	1	2	3	6	7
3	4	7	8		4	5	8	

GCST019E

- **Combine**
- Don not Combine

❖ **Copy Order in Combine**

You can set the copy order in Combine mode to Left to Right or Top to Bottom.

From Left to Right	From Top to Bottom																
<table border="1"> <tr><td>1</td><td>2</td></tr> <tr><td>3</td><td>4</td></tr> </table>	1	2	3	4	<table border="1"> <tr><td>1</td><td>3</td></tr> <tr><td>2</td><td>4</td></tr> </table>	1	3	2	4								
1	2																
3	4																
1	3																
2	4																
<table border="1"> <tr><td>1</td><td>2</td><td>3</td><td>4</td></tr> <tr><td>5</td><td>6</td><td>7</td><td>8</td></tr> </table>	1	2	3	4	5	6	7	8	<table border="1"> <tr><td>1</td><td>3</td><td>5</td><td>7</td></tr> <tr><td>2</td><td>4</td><td>6</td><td>8</td></tr> </table>	1	3	5	7	2	4	6	8
1	2	3	4														
5	6	7	8														
1	3	5	7														
2	4	6	8														

GCAH090E

- **From Left to Right**
- Bottom Left

❖ **Orientation: Booklet, Magazine**

You can select the orientation of copies to open when using Booklet or Magazine mode.

- **Open to Left**
- Open to Right

❖ **Copy on Designating Page in Combine**

You can specify whether to make a combined copy on the inserted slip sheets in Desig./Chapter mode.

- **Combine**
- Do not Combine

❖ Image Repeat Separation Line

You can select a separation line using the Image Repeat function from: None, Solid, Broken A, Broken B, or Crop Marks.

- None



- Solid



- Broken A



- Broken B



- Crop Marks



❖ Double Copies Separation Line

You can select a separation line using the Double Copies function from: None, Solid, Broken A, Broken B, or Crop Marks.

- None



- Solid



- Broken A



- Broken B



- Crop Marks



❖ **Separation Line in Combine**

You can select a separation line using the Combine function from: None, Solid, Broken A, Broken B, or Crop Marks.

- **None**



- **Solid**



- **Broken A**



- **Broken B**



- **Crop Marks**



❖ **Copy Back Cover**

When copying the back cover, you can specify whether to have the back cover outside (outside page) or inside (inside page).

- **Outside**
- **Inside**

 **Reference**

p.3 "Accessing User Tools (System Settings)"

"Booklet/Magazine", Copy / Document Server Reference

Stamp

This section describes various items of **[Stamp]** under **[Copier / Document Server Features]**.

Default settings are shown in **bold type**.

Reference

p.3 “Accessing User Tools (System Settings)”

Background Numbering

3

This section describes various items of **[Background Numbering]** under **[Stamp]**.

❖ Size

You can set the size of the numbers.

- Small
- **Normal**
- Large

❖ Density

You can set the density of the numbers.

- Light
- **Normal**
- Dark
- Very Dark

Preset Stamp

This section describes various items of **[Preset Stamp]** under **[Stamp]**.

❖ Stamp Language

You can select the language of the message printed in Stamp mode.

- English
- German
- French
- Italian
- Spanish
- Dutch
- Portuguese
- Polish
- Czech
- Swedish
- Finnish
- Hungarian
- Norwegian
- Danish
- Russian
- Japanese
- Simplified Chinese
- Traditional Chinese
- Hangul

❖ Stamp Priority

You can select the stamp type given priority when **[Preset Stamp]** is pressed.

- Copy
- Urgent
- Priority
- For Your Info.
- Preliminary
- For Internal Use Only
- Confidential
- Drefit

❖ Stamp Format

You can specify how each of stamp is printed.

- Stamp Position
You can specify where to print the stamp.
 - Top Left
 - Top Centre
 - **Top Right**
 - Centre Left
 - Centre
 - Centre Right
 - Bottom Left
 - Btm Centre
 - Bottom Right
- Stamp Position
You can adjust the position of the stamp within the available range as shown below.
Metric version:
 - "Top Left"...T/B: 4-144mm, L/R: 4-144mm
 - "Top Centre"...T/B: 4-144mm, L/R: 72-72mm
 - "Top Right"...T/B: 4-144mm, L/R: 4-144mm
 - "Centre Left"...T/B: 72-72mm, L/R: 4-144mm
 - "Centre"...T/B: 72-72mm, L/R: 72-72mm
 - "Centre Right"...T/B: 72-72mm, L/R: 4-144mm
 - "Bottom Left"...T/B: 4-144mm, L/R: 4-144mm
 - "Btm Centre"...T/B: 4-144mm, L/R: 72-72mm
 - "Bottom Right"...T/B: 4-144mm, L/R: 4-144mm
 Inch version:
 - "Top Left"...T/B: 0.1"-5.7", L/R: 0.1"-5.7"
 - "Top Centre"...T/B: 0.1"-5.7", L/R: 2.8"-2.8"
 - "Top Right"...T/B: 0.1"-5.7", L/R: 0.1"-5.7"
 - "Centre Left"...T/B: 2.8"-2.8", L/R: 0.1"-5.7"
 - "Centre"...T/B: 2.8"-2.8", L/R: 2.8"-2.8"
 - "Centre Right"...T/B: 2.8"-2.8", L/R: 0.1"-5.7"
 - "Bottom Left"...T/B: 0.1"-5.7", L/R: 0.1"-5.7"
 - "Btm Centre"...T/B: 0.1"-5.7", L/R: 2.8"-2.8"
 - "Bottom Right"...T/B: 0.1"-5.7", L/R: 0.1"-5.7"

- **Size**
You can set the size of the stamp.
 - 1 X
 - 2 X
 - 4 X
- **Density**
You can set the pattern used to print the stamp.
 - **Normal**
The stamp is printed on the image. You cannot check which parts will overlap.
 - **Lighter**
The image can be seen through the stamp.
 - **Lightest**
The image appears even clearer than in the Lighter setting.
- **Page to Stamp**
You can have the stamp printed on the first page or all pages.
 - **All Pages**
 - 1st Page Only

Reference

"Preset Stamp", Copy / Document Server Reference

User Stamp

This section describes various items of **[User Stamp]** under **[Stamp]**.

❖ **Program / Delete Stamp**

You can register, change, or delete these designs as user stamps.
You can register up to four custom stamps with your favourite designs.

❖ **Stamp Format:1, Stamp Format:2, Stamp Format:3, Stamp Format:4**

You can specify how each of registered User Stamps 1 to 4 is printed.

- **Stamp Position**
You can specify where to print the User Stamp.
 - Top Left
 - Top Centre
 - **Top Right**
 - Centre Left
 - Centre
 - Centre Right
 - Bottom Left
 - Bottom Centre
 - Bottom Right

- Stamp Position

You can adjust the position of the User Stamp within the available range as shown below.

Metric version:

- "Top Left" ...T/B: 4-144mm, L/R: 4-144mm
- "Top Centre" ...T/B: 4-144mm, L/R: 72-72mm
- "Top Right" ...T/B: 4-144mm, L/R: 4-144mm
- "Centre Left" ...T/B: 72-72mm, L/R: 4-144mm
- "Centre" ...T/B: 72-72mm, L/R: 72-72mm
- "Centre Right" ...T/B: 72-72mm, L/R: 4-144mm
- "Bottom Left" ...T/B: 4-144mm, L/R: 4-144mm
- "Bttm Centre" ...T/B: 4-144mm, L/R: 72-72mm
- "Bottom Right" ...T/B: 4-144mm, L/R: 4-144mm

Inch version:

- "Top Left" ...T/B: 0.1"-5.7", L/R: 0.1"-5.7"
 - "Top Centre" ...T/B: 0.1"-5.7", L/R: 2.8"-2.8"
 - "Top Right" ...T/B: 0.1"-5.7", L/R: 0.1"-5.7"
 - "Centre Left" ...T/B: 2.8"-2.8", L/R: 0.1"-5.7"
 - "Centre" ...T/B: 2.8"-2.8", L/R: 2.8"-2.8"
 - "Centre Right" ...T/B: 2.8"-2.8", L/R: 0.1"-5.7"
 - "Bottom Left" ...T/B: 0.1"-5.7", L/R: 0.1"-5.7"
 - "Bttm Centre" ...T/B: 0.1"-5.7", L/R: 2.8"-2.8"
 - "Bottom Right" ...T/B: 0.1"-5.7", L/R: 0.1"-5.7"
- Page to Stamp
Sets whether to print the stamp on all pages or only the first page.
 - All Pages
 - 1st Page Only

Reference

"User Stamp", Copy/ Document Server Reference

Date Stamp

This section describes various items of **[Date Stamp]** under **[Stamp]**.

❖ **Format**

You can select the date format for Date Stamp mode.

- MM / DD / YYYY
- MM.DD.YYYY
- **DD / MM / YYYY**
- DD.MM.YYYY
- YYYY.MM.DD

❖ **Font**

You can select the Date Stamp font.

- **Font 1**
- Font 2
- Font 3

❖ **Size**

You can set the Date Stamp size.

- **Auto**
- Large
- Middle
- Small

❖ **Superimpose**

You can have the Date Stamp printed in white when it overlaps black parts of the image.

- On
- **Off**

❖ **Stamp Setting**

You can specify how Date Stamp is printed.

- Stamp Position
You can specify where to print the Date Stamp.
 - **Top Left**
 - Top Centre
 - Top Right
 - Bottom Left
 - Bottom Centre
 - Bottom Right

- **Stamp Position**
You can adjust the position of the Date Stamp within the available range as shown below.
Metric version:
 - "Top Left"...T/B: 4-144mm, L/R: 4-144mm
 - "Top Centre"...T/B: 4-144mm, L/R: 72-72mm
 - "Top Right"...T/B: 4-144mm, L/R: 4-144mm
 - "Bottom Left"...T/B: 4-144mm, L/R: 4-144mm
 - "Bttm Centre"...T/B: 4-144mm, L/R: 72-72mm
 - "Bottom Right"...T/B: 4-144mm, L/R: 4-144mm
 Inch version:
 - "Top Left"...T/B: 0.1"-5.7", L/R: 0.1"-5.7"
 - "Top Centre"...T/B: 0.1"-5.7", L/R: 2.8"-2.8"
 - "Top Right"...T/B: 0.1"-5.7", L/R: 0.1"-5.7"
 - "Bottom Left"...T/B: 0.1"-5.7", L/R: 0.1"-5.7"
 - "Bttm Centre"...T/B: 0.1"-5.7", L/R: 2.8"-2.8"
 - "Bottom Right"...T/B: 0.1"-5.7", L/R: 0.1"-5.7"
- **Page to Stamp**
Sets whether to print the stamp on all pages or only the first page.
 - **All Pages**
 - 1st Page Only

Page Numbering

This section describes various items of **[Page Numbering]** under **[Stamp]**.

❖ Stamp Format

You can select the page number format given priority when **[Page Numbering]** is pressed.

- **P1,P2...**
- 1/5,2/5...
- -1,-2-...
- P.1,P.2...
- 1,2...
- 1-1,1-2...

❖ Font

You can select the page number printed in Page Numbering mode.

- **Font 1**
- Font 2
- Font 3

❖ Size

You can set the size of the stamp printed in Page Numbering mode.

- **Auto**
- Large
- Middle
- Small

❖ Duplex Back Page Stamping Position

You can set the position of the duplex back page number printed in Duplex mode.

- **Opposite Position**
- Same Position

❖ Page Numbering in Combine

You can set page numbering when using the Combine function and the Page Numbering function together.

- **Per Original**
- Per Copy

❖ Stamp on Designating Slip Sheet

You can select to print the page number onto slip sheets when using the Designate function set to **[Copy]** and the Page Numbering function together.

- On
- **Off**

❖ Stamp Position

You can specify how each of stamp is printed.

- Stamp Position
You can specify where to print the stamp.
 - Top Left
 - Top Centre
 - **Top Right**
 - Bottom Left
 - Bottom Centre
 - Bottom Right

For the patterns of "P1, P2, ---", "1/5, 2/5, ---", "P.1, P.2, ---", and "1, 2, ---", the machine is shipped from the factory with this position set to "Top right". For the patterns of "-1-, -2-, ---" and "1-1, 1-2, ---", the machine has this position set to "Bottom centre".

The setting range is as follows:

- **Stamp Position**

You can adjust the position of the stamp within the available range as shown below.

Metric version:

- "Top Left" ...T/B: 4-144mm, L/R: 4-144mm
- "Top Centre" ...T/B: 4-144mm, L/R: 72-72mm
- "Top Right" ...T/B: 4-144mm, L/R: 4-144mm
- "Bottom Left" ...T/B: 4-144mm, L/R: 4-144mm
- "Bttm Centre" ...T/B: 4-144mm, L/R: 72-72mm
- "Bottom Right" ...T/B: 4-144mm, L/R: 4-144mm

Inch version:

- "Top Left" ...T/B: 0.1"-5.7", L/R: 0.1"-5.7"
- "Top Centre" ...T/B: 0.1"-5.7", L/R: 2.8"-2.8"
- "Top Right" ...T/B: 0.1"-5.7", L/R: 0.1"-5.7"
- "Bottom Left" ...T/B: 0.1"-5.7", L/R: 0.1"-5.7"
- "Bttm Centre" ...T/B: 0.1"-5.7", L/R: 2.8"-2.8"
- "Bottom Right" ...T/B: 0.1"-5.7", L/R: 0.1"-5.7"

- ❖ **Superimpose**

You can have page numbers printed in white when they overlap black parts of the image.

- On
- Off

- ❖ **Page Numbering Initial Letter**

Switch the page print language.

- P1,P2.../P.1,P.2...
- S1,S2.../S.1,S.2...

Stamp Text

This section describes various items of **[Stamp Text]** under **[Stamp]**.

❖ Font

You can select the Stamp Text font.

- **Font 1**
- Font 2
- Font 3

❖ Size

You can set the Stamp Text size.

- **Auto**
- Large
- Middle
- Small

❖ Superimpose

You can have the Stamp Text printed in white when it overlaps black parts of the image.

- On
- **Off**

❖ Stamp Setting

You can specify how Stamp Text is printed.

- Stamp Position
You can specify where to print the Stamp Text.
 - Top Left
 - Top Centre
 - **Top Right**
 - Bottom Left
 - Bottom Centre
 - Bottom Right

- Stamp Position

You can adjust the position of the Stamp Text within the available range as shown below.

Metric version:

- "Top Left"...T/B: 4-144mm, L/R: 4-144mm
- "Top Centre"...T/B: 4-144mm, L/R: 72-72mm
- "Top Right"...T/B: 4-144mm, L/R: 4-144mm
- "Bottom Left"...T/B: 4-144mm, L/R: 4-144mm
- "Bttm Centre"...T/B: 4-144mm, L/R: 72-72mm
- "Bottom Right"...T/B: 4-144mm, L/R: 4-144mm

Inch version:

- "Top Left"...T/B: 0.1"-5.7", L/R: 0.1"-5.7"
 - "Top Centre"...T/B: 0.1"-5.7", L/R: 2.8"-2.8"
 - "Top Right"...T/B: 0.1"-5.7", L/R: 0.1"-5.7"
 - "Bottom Left"...T/B: 0.1"-5.7", L/R: 0.1"-5.7"
 - "Bttm Centre"...T/B: 0.1"-5.7", L/R: 2.8"-2.8"
 - "Bottom Right"...T/B: 0.1"-5.7", L/R: 0.1"-5.7"
- Page to Stamp
Sets whether to print the stamp on all pages or only the first page.
 - **All Pages**
 - 1st Page Only

Input/Output

This section describes various items of **[Input / Output]** under **[Copier / Document Server Features]**.

Default settings are shown in **bold type**.

❖ **Switch to Batch**

You can select to have Batch mode or SADF mode displayed when you press the **[Special Original]** key.

- **Batch**
- SADF

❖ **SADF Auto Reset**

In SADF mode, an original must be set within a specified time after the previous original has been fed.

You can adjust this time from 3 to 99 seconds in increments of 1 second.

The timing is set to "**5 second(s)**" by default.

❖ **Rotate Sort: Auto Paper Continue**

You can specify to continue copying when paper of the required orientation has run out during rotatesorting.

- **On**
Copying continues using copy paper of a different orientation. The copy job will finish even if you have left the machine.
- **Off**
When paper of the required orientation runs out, the machine stops copying and prompts you to supply copy paper. After you have loaded paper, the machine will continue copying.

❖ **Copy Eject Face Method in Glass Mode**

You can specify the way in which copies are delivered when copying an original placed on the exposure glass.

- **Face Up**
- Face Down

❖ **Copy Eject Face Method in Bypass Mode**

You can specify the way in which copies are delivered when copying in Bypass mode.

- **Face Up**
- Face Down

❖ **Memory Full Auto Scan Restart**

When memory becomes full while scanning originals, the machine can make copies of scanned originals first, and then automatically proceed scanning remaining originals.

- **On**
You can leave the machine unattended to make copies, but sorted pages will not be sequential.
- **Off**
When memory becomes full, the machine stops operation allowing you to remove the copy pages delivered on the output tray.

❖ **Letterhead Setting**

If you select **[Yes]** in this function, the machine rotates the image correctly.

- **Yes**
- **No**
Orientation-fixed (top to bottom) or two-sided paper might not be printed correctly depending on how the originals and paper are placed.

❖ **Staple Position**

Specify which Top 2 staples or Bottom shown on the initial display with priority.

The optional 3,000Sheet Finisher, or Booklet Finisher is required to use this function.

- Top 1
- Centre
- Left 2
- Top 2
- Bottom 1
- Slant
- Off

❖ **Punch Type**

Specify which punch type (2 holes or 3 holes) has priority to be shown on the initial display.

The optional 3,000Sheet Finisher, or Booklet Finisher is required to use this function.

- 2 Holes Left
- 2 Holes top
- 3 Holes left
- 3 Holes Top
- 4 Holes Left
- 4 Holes Top
- Off

❖ **Simplified Screen: Finishing Types**

You can select which key is displayed with higher priority for “Finishing Types” on the Simplified Screen.

- Stack
- Slant
- Top 1
- Bottom 1
- Left 2
- 2 Holes Left
- 3 Holes Left
- 4 Holes Left
- Do not Display

Reference

"Orientation-Fixed Paper or Two-Sided Paper", Troubleshooting

"Batch mode", Copy/ Document Server Reference

"Sort", Copy/ Document Server Reference

Settings for the Document Server

Default settings are shown in **bold type**.

For details, see "System Settings", and "Copier/Document Server Features".

❖ Copier/Document Server Features

Heading	items	Default
General Features	Customize Function : Document Server Storage	2 Sided Orig. Top to Top
General Features	Customize Function : Document Server Storage	1 sided→Comb 2 orig
General Features	Customize Function : Document Server Storage	1 sided→Comb 4 orig
General Features	Customize Function : Document Server Storage	1 sided→Comb 8 orig
General Features	Customize Function : Document Server Storage	Create Margin
General Features	Customize Function : Document Server Storage	Off
General Features	Customize Function : Document Server Print	Duplex Print Top to Top
General Features	Customize Function : Document Server Print	Duplex Print Top to Bottom
General Features	Customize Function : Document Server Print	Booklet
General Features	Customize Function : Document Server Print	Magazine
General Features	Customize Function : Document Server Print	Off
General Features	Customize Function : Document Server Print	Off

❖ **System Settings**

Heading	Item	Default
General Features	Warm-up Beeper	On
General Features	Copy Count Display	Up
General Features	Output: Document Server	Copy Tray
Tray Paper Settings	Paper Tray Priority: Copier	Tray 1
Tray Paper Settings	Front Cover Sheet Tray	Off
Tray Paper Settings	Back Cover Sheet Tray	Off
Tray Paper Settings	Slip Sheet Tray	Off
Tray Paper Settings	Designation Sheet 1 Tray, Designation Sheet 2 Tray	Off
Timer Settings	Copier/Document Server Auto Reset Timer	60 second(s)
Administrator Tools	Auto Delete File in Document Server	3 daay(s)
Administrator Tools	Delete All Files in Document Server	-

 **Reference**

- p.3 “Accessing User Tools (System Settings)”
- p.41 “System Settings”
- p.95 “Copier/Document Server Features”

Copier/Document Server Features on Main and Sub-machines

This section explains the Copier/Document Server Features on the two machines during Connect Copy.

While connect copy is under way, the **[User Tools/Counter]** keys of the sub-machines remain disabled. If it is desired to change the defaults, press **[Connect Copy]** that appears in reverse video on the control screen of the main machine, and then, clear the connect copy before making changes.

3

General Features

How the defaults in the General Features of copying of the main and sub-machines are used in connect copy will be explained.

❖ Auto Image Density Priority

- The main machine applies the setting that has been made on it. Sub-machine settings do not affect connect copy.

❖ Copy Quality

- The main machine applies the setting that has been made on it. Sub-machine settings do not affect connect copy.

❖ Image Density

- The main machine applies the setting that has been made on it. Sub-machine settings do not affect connect copy.

❖ Original Orientation in Duplex Mode

- The main machine applies the setting that has been made on it. Sub-machine settings do not affect connect copy.

❖ Copy Orientation in Duplex Mode

- The main machine applies the setting that has been made on it. Sub-machine settings do not affect connect copy.

❖ Max. Copy Quantity

- The main machine applies the setting that has been made on it. Sub-machine settings do not affect connect copy.

❖ Auto Tray Switching

- The main machine applies the setting that has been made on it. Sub-machines also apply their own respective settings.

❖ Paper Display

- The main machine applies the setting that has been made on it. Sub-machine settings do not affect connect copy.

❖ Original Type Display

- The main machine applies the setting that has been made on it. Sub-machine settings do not affect connect copy.

❖ Tone: Original Remains

- The main machine applies the setting that has been made on it. Sub-machine settings do not affect connect copy.

❖ Job End Call

- The main machine applies the settings that have been made on it. Sub-machines also apply the settings made on the main machine, regardless of the settings made on them.
- When **[On]** is selected, only the main machine beeper sounds.

❖ Connect Copy Key Display

- The main machine applies the setting that has been made on it. Sub-machines also apply their own respective settings.

❖ Switch Original Counter Display

- The main machine applies the setting that has been made on it. Sub-machine settings do not affect connect copy.

❖ Customize Function: Copier

- The main machine applies the setting that has been made on it. Sub-machine settings do not affect connect copy.

❖ Customize Function: Document Server Storage

- The main machine applies the setting that has been made on it. Sub-machine settings do not affect connect copy.

❖ Customize Function: Document Server Print

- The main machine applies the setting that has been made on it. Sub-machine settings do not affect connect copy.

Reproduction Ratio

How the defaults in the Reproduction Ratio of copying of the main and sub-machines are used in connect copy will be explained.

❖ **Shortcut R / E**

- The main machine applies the setting that has been made on it. Sub-machine settings do not affect connect copy.

❖ **R / E Ratio**

- The main machine applies the setting that has been made on it. Sub-machine settings do not affect connect copy.

❖ **R / E Ratio Priority**

- The main machine applies the setting that has been made on it. Sub-machine settings do not affect connect copy.

❖ **Ratio for Create Margin**

- The main machine applies the setting that has been made on it. Sub-machine settings do not affect connect copy.

Edit

How the defaults in the Edit of copying of the main and sub-machines are used in connect copy will be explained.

❖ **Front Margin: Left / Right**

- The main machine applies the settings that have been made on it. Sub-machines also apply the settings made on the main machine, regardless of the settings made on them.
- Settings made on the main machine are applied.

❖ **Back Margin: Left / Right**

- The main machine applies the settings that have been made on it. Sub-machines also apply the settings made on the main machine, regardless of the settings made on them.
- Settings made on the main machine are applied.

❖ **Front Margin: Top / Bottom**

- The main machine applies the settings that have been made on it. Sub-machines also apply the settings made on the main machine, regardless of the settings made on them.
- Settings made on the main machine are applied.

❖ Back Margin: Top / Bottom

- The main machine applies the settings that have been made on it. Sub-machines also apply the settings made on the main machine, regardless of the settings made on them.
- Settings made on the main machine are applied.

❖ 1 Sided → 2 Sided Auto Margin: TtoT

- The main machine applies the settings that have been made on it. Sub-machines also apply the settings made on the main machine, regardless of the settings made on them.
- Settings made on the main machine are applied.

❖ 1 Sided → 2 Sided Auto Margin: TtoB

- The main machine applies the settings that have been made on it. Sub-machines also apply the settings made on the main machine, regardless of the settings made on them.
- Settings made on the main machine are applied.

❖ Erase Border Width

- The main machine applies the settings that have been made on it. Sub-machines also apply the settings made on the main machine, regardless of the settings made on them.
- Settings made on the main machine are applied.

❖ Erase Original Shadow in Combine

- The main machine applies the settings that have been made on it. Sub-machines also apply the settings made on the main machine, regardless of the settings made on them.

❖ Erase Centre Width

- The main machine applies the settings that have been made on it. Sub-machines also apply the settings made on the main machine, regardless of the settings made on them.

❖ Front Cover Copy in Combine

- The main machine applies the settings that have been made on it. Sub-machines also apply the settings made on the main machine, regardless of the settings made on them.

❖ Copy Order in Combine

- The main machine applies the settings that have been made on it. Sub-machines also apply the settings made on the main machine, regardless of the settings made on them.

❖ Orientation: Booklet, Magazine

- The main machine applies the settings that have been made on it. Sub-machines also apply the settings made on the main machine, regardless of the settings made on them.

❖ Copy on Designating Page in Combine

- The main machine applies the settings that have been made on it. Sub-machines also apply the settings made on the main machine, regardless of the settings made on them.

❖ Image Repeat Separation Line

- The main machine applies the settings that have been made on it. Sub-machines also apply the settings made on the main machine, regardless of the settings made on them.

❖ Double Copies Separation Line

- The main machine applies the settings that have been made on it. Sub-machines also apply the settings made on the main machine, regardless of the settings made on them.

❖ Separation Line in Combine

- The main machine applies the settings that have been made on it. Sub-machines also apply the settings made on the main machine, regardless of the settings made on them.

❖ Copy Back Cover

- The main machine applies the settings that have been made on it. Sub-machines also apply the settings made on the main machine, regardless of the settings made on them.
- Settings made on the main machine are applied.

Stamp

How the defaults in the Stamp of copying of the main and sub-machines are used in connect copy will be explained.

Background Numbering

❖ Size

- The main machine applies the settings that have been made on it. Sub-machines also apply the settings made on the main machine, regardless of the settings made on them.

❖ Density

- The main machine applies the settings that have been made on it. Sub-machines also apply the settings made on the main machine, regardless of the settings made on them.
-

Preset Stamp

❖ Stamp Language

- The main machine applies the settings that have been made on it. Sub-machines also apply the settings made on the main machine, regardless of the settings made on them.

❖ Stamp Priority

- The main machine applies the settings that have been made on it. Sub-machines also apply the settings made on the main machine, regardless of the settings made on them.

❖ Stamp Format

- The main machine applies the settings that have been made on it. Sub-machines also apply the settings made on the main machine, regardless of the settings made on them.
-

User Stamp

❖ Program / Delete Stamp

- The main machine applies the settings that have been made on it. Sub-machines also apply the settings made on the main machine, regardless of the settings made on them.

❖ Stamp Format:1, Stamp Format:2, Stamp Format:3, Stamp Format:4

- The main machine applies the settings that have been made on it. Sub-machines also apply the settings made on the main machine, regardless of the settings made on them.

Date Stamp

❖ Format

- The main machine applies the settings that have been made on it. Sub-machines also apply the settings made on the main machine, regardless of the settings made on them.

❖ Font

- The main machine applies the settings that have been made on it. Sub-machines also apply the settings made on the main machine, regardless of the settings made on them.

❖ Size

- The main machine applies the settings that have been made on it. Sub-machines also apply the settings made on the main machine, regardless of the settings made on them.

❖ Superimpose

- The main machine applies the settings that have been made on it. Sub-machines also apply the settings made on the main machine, regardless of the settings made on them.

❖ Stamp Setting

- The main machine applies the settings that have been made on it. Sub-machines also apply the settings made on the main machine, regardless of the settings made on them.

Page Numbering

❖ Stamp Format

- The main machine applies the settings that have been made on it. Sub-machines also apply the settings made on the main machine, regardless of the settings made on them.

❖ Font

- The main machine applies the settings that have been made on it. Sub-machines also apply the settings made on the main machine, regardless of the settings made on them.

❖ Size

- The main machine applies the settings that have been made on it. Sub-machines also apply the settings made on the main machine, regardless of the settings made on them.

❖ Duplex Back Page Stamping Position

- The main machine applies the settings that have been made on it. Sub-machines also apply the settings made on the main machine, regardless of the settings made on them.

❖ Page Numbering in Combine

- The main machine applies the settings that have been made on it. Sub-machines also apply the settings made on the main machine, regardless of the settings made on them.

❖ Stamp on Designating Slip Sheet

- The main machine applies the settings that have been made on it. Sub-machines also apply the settings made on the main machine, regardless of the settings made on them.

❖ Stamp Position

- The main machine applies the settings that have been made on it. Sub-machines also apply the settings made on the main machine, regardless of the settings made on them.

❖ Superimpose

- The main machine applies the settings that have been made on it. Sub-machines also apply the settings made on the main machine, regardless of the settings made on them.

❖ Page Numbering Initial Letter

- The main machine applies the settings that have been made on it. Sub-machines also apply the settings made on the main machine, regardless of the settings made on them.

Stamp Text

❖ Font

- The main machine applies the settings that have been made on it. Sub-machines also apply the settings made on the main machine, regardless of the settings made on them.

❖ Size

- The main machine applies the settings that have been made on it. Sub-machines also apply the settings made on the main machine, regardless of the settings made on them.

❖ Superimpose

- The main machine applies the settings that have been made on it. Sub-machines also apply the settings made on the main machine, regardless of the settings made on them.

❖ Stamp Setting

- The main machine applies the settings that have been made on it. Sub-machines also apply the settings made on the main machine, regardless of the settings made on them.

Input/Output

How the defaults in the Stamp of copying of the main and sub-machines are used in connect copy will be explained.

❖ Switch to Batch

- Settings made on the main and sub-machines do not affect the connect copy.

❖ SADF Auto Reset

- The main machine applies the setting that has been made on it. Sub-machine settings do not affect connect copy.

❖ Rotate Sort: Auto Paper Continue

- The main machine applies the setting that has been made on it. Sub-machine settings do not affect connect copy.
- This function is effective when Auto Tray Switching in User Tools (System Settings) is set to "On (Rotate)".

❖ Copy Eject Face Method in Glass Mode

- Settings made on the main and sub-machines do not affect the connect copy.

❖ Copy Eject Face Method in Bypass Mode

- Settings made on the main and sub-machines do not affect the connect copy.

❖ Memory Full Auto Scan Restart

- The main machine applies the settings that have been made on it. Sub-machines also apply the settings made on the main machine, regardless of the settings made on them.

❖ Letterhead Setting

- The main machine applies the settings that have been made on it. Sub-machines also apply the settings made on the main machine, regardless of the settings made on them.

❖ Staple Position

- The main machine applies the setting that has been made on it. Sub-machine settings do not affect connect copy.

❖ **Punch Type**

- The main machine applies the settings that have been made on it. Sub-machines also apply the settings made on the main machine, regardless of the settings made on them.

❖ **Simplified Screen: Finishing Types**

- Settings made on the main and sub-machines do not affect the connect copy.
- The connect copy function is not available from the simple display.

4. Printer Features

This chapter explains various items of **[Printer Features]** available in this machine.

List/Test Print

This section describes various items of **[List / Test Print]** under **[Printer Features]**.

Default settings are shown in **bold type**.

This is an item relating to the test print, such as for printing a system setup list, etc. If you change settings related to printing or the machine's operating environment, we recommend you print a settings list for reference.

All the printable characters and font types can also be printed for checking.

❖ Multiple Lists

You can print the configuration page and error log.

❖ Configuration Page

You can print the machine's current configuration values.

❖ Error Log

You can print error logs listing all errors that occurred during printing. The most recent 50 errors are stored in the error log. If a new error is added when there are 50 errors already stored, the oldest error is deleted. However, if the oldest error belongs to one of the following print jobs, it is not deleted. The error is stored separately until the number of those errors reaches 30.

The error history is printed only if there are errors to report. A confirmation message appears in the control section.

❖ Menu List

You can print a Menu List showing the machine's function menus.

❖ PCL Configuration / Font Page

You can print the current configuration and installed PCL font list.

❖ PS Configuration / Font Page

You can print the current configuration and installed PostScript font list.

This menu can be selected only when the optional PostScript 3 unit is installed.

❖ PDF Configuration / Font Page

You can print the current configuration and installed PDF font list.

This menu can be selected only when the optional PostScript 3 unit is installed.

❖ Hex Dump

You can print in the Hex Dumpmode.

🔍 Reference

p.3 "Accessing User Tools (System Settings)"

Printing the configuration page

1 Press [Printer Features].

2 Press [Configuration Page] on the [List / Test Print].

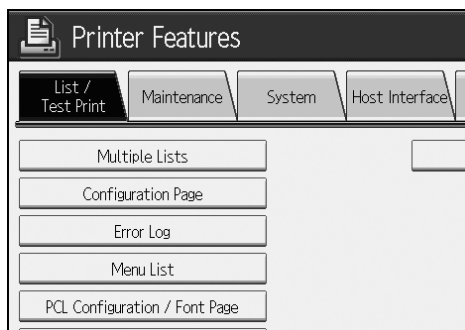

The configuration page is printed.

However, if you select [Hex Dump], the setting is made, but nothing is printed.

3 Press the [User Tools/Counter] key.

Interpreting the configuration page

❖ System Reference

- Unit Number
Displays the serial number assigned to the board by its manufacturer.
- Total Memory
Displays the total amount of memory (SDRAM) installed on the printer.
- Firmware Version
 - Printer
Displays the version number of the printer firmware.
 - System
Displays the version number of the system firmware.
 - Engine
Displays the version number of the printer engine.
 - LCDC
Displays the version number of the panel display.
 - NIB
Displays the version number of the Network interface.
- Device Connection
This item(s) appears when the device option(s) is installed.
- HDD: Font / Macro Download
Displays the capacity of the hard disk drive.

- **Printer Language**
Displays the version number of the printer driver language.
- **Connection Equipment**
Displays the installed optional equipments.
- ❖ **Paper Input**
Displays settings made under Tray Paper Settings menu.
- ❖ **System**
Displays settings made under the System menu.
- ❖ **PCL Menu**
Displays settings made under PCL Menu.
- ❖ **PS Menu**
Displays settings made under PS Menu.
- ❖ **PDF Menu**
Displays settings made under PDF Menu.
- ❖ **Host Interface**
Displays settings made under the Host Interface menu.
When DHCP is active on the network, the actual IP address, subnet mask and gateway address appear in parentheses on the configuration page.
- ❖ **Interface Information**
Displays the interface information.

Maintenance

This section describes various items of **[Maintenance]** under **[Printer Features]**. Default settings are shown in **bold type**.

❖ **List / Test Print Lock**

You can lock the **[List / Test Print]** menu.

- On
- **Off**

❖ **Delete All Temporary Print Jobs**

You can delete all print jobs temporarily stored in the machine.

❖ **Delete All Stored Print Jobs**

You can delete all print jobs stored in the machine.

🔍 **Reference**

p.3 “Accessing User Tools (System Settings)”

p.41 “System Settings”

System

This section describes various items of **[System]** under **[Printer Features]**.

Default settings are shown in **bold type**.

❖ **Print Error Report**

Select this to have an error report printed when a printer or memory error occurs.

- On
- **Off**

❖ **Auto Continue**

You can select this to enable Auto Continue. When it is On, printing continues after a system error occurs.

- **Off**
- Immediate
- 1 minute
- 5 minutes
- 10 minutes
- 15 minutes

❖ **Memory Overflow**

Select this to have a memory overflow error report printed.

- **Do not Print**
- Error Information

❖ **Job Separation**

You can enable Job Separation.

This menu can be selected only when a finisher (optional) is installed.

- On
- **Off**

❖ **Auto Delete Temporary Print Jobs**

You can select to automatically delete print jobs temporarily stored in the machine.

- On
- **Off**

If you select **[On]**, you can set up to 200 hours for auto file deleting.

❖ **Auto Delete Stored Print Jobs**

You can select to automatically delete print jobs stored in the machine.

- **On: 3 days**
- Off

If you select **[On]**, you can set up to 180 days for auto file deleting.

❖ Initial Print Job List

You can set the desired type of print job list that appears on the screen when you press **[Print Jobs]**.

- **Complete List**
Displays the list of print jobs stored in the machine.
- **List Per User ID**
Displays the list of the User ID who stored a file in the machine.

❖ Memory Usage

You can select the amount of memory used in Font Priority or Frame Priority, according to paper size or resolution.

- **Font Priority**
This setting uses memory for registering fonts.
- **Frame Priority**
This setting uses frame memory for high speed printing.

❖ Duplex

Set two-sided printing.

- **Off**
- **Long Edge Bind**
- **Short Edge Bind**

❖ Copies

Set the number of copies from 1 to 999 in units of one copy. The default setting is "1 copy".

- 1-999
Default: 1

❖ Blank Page Print

You can select whether or not to print blank pages.

- **On**
 - **Off**
- Pages that match one of the following conditions are identified as blank.
- There are no images.
 - There are images but they are outside of the printable area.
 - There are only blank characters.

❖ Toner Saving

Select either to apply or not to apply Toner Saving.

- **On**
- **Off**

❖ Spool Image

You can select to print spool images. The print job transmitted from the computer is temporarily stored on the machine's hard disk as bitmap images that can be printed when transmission is complete. If more than one print job is transmitted, a spool image is printed for each.

- **Off**
- On

❖ Reserved Job Waiting Time

You can specify how long the machine waits to receive a print job before allowing other functions such as the copier and scanner functions to interrupt it.

- Long Wait
- Medium Wait
- **Short Wait**
- In Reserved Job Order

❖ Printer Language

You can specify the printer language.

- **Auto**
- PCL
- PS
- PDF

This menu appears only when the PostScript 3 unit (optional) is installed.

❖ Sub Paper Size

You can enable the Auto Substitute Paper Size (A4.LT) feature.

- Auto
- **Off**

❖ Page Size

You can select the default paper size.

- A3
- B4 JIS
- A4
- B5 JIS
- A5
- B6
- A6
- 11×17
- 8¹/₂×14
- 8¹/₂×13
- 8¹/₂×11
- 8¹/₄×13
- 8×13
- 7¹/₄×10¹/₂
- 5¹/₂×8¹/₂
- 8K
- 16K
- Custom Size

Default: Metric version: **A4**, Inch version: **8¹/₂×11**

The paper size currently set for the bypass tray is applied.

❖ Letterhead Setting

You can rotate original images when printing.

When printing, original images are always rotated by 180 degrees. Therefore, output might not be as expected when printing onto letterhead or preprinted paper requiring orientation. Using this function, you can specify image rotation.

- **Off**
When set to Off, original images are rotated by 180 degrees.
- **Auto Detect**
When set to Auto Detect, the machine detects a letterhead or preprinted paper automatically, and does not rotate them.
- **On (Always)**
When set to On (Always), the machine does not rotate.

This function reduces printing speed.

❖ Bypass Tray Setting Priority

You can specify which of the two options, (Printer) Driver / Command or Machine Settings, has priority for determining the paper size for the bypass tray.

- **Driver / Command**
- **Machine Settings**

❖ Edge to Edge Print

You can select whether or not to print on the entire sheet.

- On
- **Off**

The 5 mm margin along the edges may not be printed properly.

❖ Default Printer Language

You can set the default printer language if the machine cannot find the printer language automatically.

- **PCL**
- PS
- PDF

This menu appears only when the PostScript 3 unit (optional) is installed.

❖ Tray Switching

You can set to switch the paper tray.

- **Off**
- On

❖ Collate Type

You can set the default collate type if the machine cannot find the printer language automatically.

- **Collate**
- Shift Collate

❖ Staple Type

You can set the default staple type if the machine cannot find the printer language automatically.

This menu appears only when a finisher (optional) is installed.

- **Off**
- Top Left Slant
- Top Right Slant
- Left 2
- Top 2
- Right 2
- Top Left
- Top Right
- Centre

❖ Punch Type

You can set the default punch type if the machine cannot find the printer language automatically.

This menu appears only when the optional punch is installed.

Displayed items will differ depending on the finisher type, the original's orientation, the paper size, and the orientation type.

- **Off**
- Left 2
- Top 2
- Right 2
- Left 3
- Top 3
- Right 3
- Left 4
- Top 4
- Right 4

 Reference

p.3 "Accessing User Tools (System Settings)"

"Loading paper", Troubleshooting

Host Interface

This section describes various items of **[Host Interface]** under **[Printer Features]**. Default settings are shown in **bold type**.

❖ I/O Buffer

You can set the size of the I/O Buffer. Normally it is not necessary to change this setting.

- **128 KB**
- 256KB

❖ I/O Timeout

You can set how many seconds the machine should wait before ending a print job. If data from another port usually arrives in the middle of a print job, you should increase this timeout period.

- 10 seconds
- **15 seconds**
- 20 seconds
- 25 seconds
- 60 seconds

🔍 Reference

p.3 “Accessing User Tools (System Settings)”

PCL Menu

This section describes various items of **[PCL Menu]** under **[Printer Features]**. Default settings are shown in **bold type**.

❖ Orientation

You can set the page orientation.

- **Portrait**
- Landscape

❖ Form Lines

You can set the number of lines per page.

- 5 to 128 by 1
- Default: Metric version: 64, Inch version: 60

❖ Font Source

You can set the storage location of the default font.

- **Resident**
- RAM
- HDD
- SD

RAM, HDD and SD can be selected only when fonts have been downloaded to the machine.

❖ Font Number

You can set the ID of the default font you want to use.

- 0 to 63 by 1
- The ID is set to "0" by default.

❖ Point Size

You can set the point size you want to use for the selected font.

- 4.00 to 999.75 by 0.25
- This setting is effective only with variable-space fonts.
The size is set to "**12.00**" by default.

❖ Font Pitch

You can set the number of characters per inch for the selected font.

- 0.44 to 99.99 by 0.01
- This setting is effective only with fixed-space fonts.
The font pitch is set to "**10.00**" by default.

❖ Symbol Set

You can specify the set of print characters for the selected font. The available options are as follows:

Roman-8, ISO L1, ISO L2, ISO L5, **PC-8**, PC-8 D/N, PC-850, PC-852, PC8-TK, Win L1, Win L2, Win L5, Desktop, PS Text, VN Intl, VN US, MS Publ, Math-8, PS Math, VN Math, Pifont, Legal, ISO 4, ISO 6, ISO 11, ISO 15, ISO 17, ISO 21, ISO 60, ISO 69, Win 3.0

❖ Courier Font

You can select a courier font type.

- **Regular**
- Dark

❖ Extend A4 Width

You can extend the printing area width (when printing on A4 sheet with PCL).

- On
- **Off**

When the setting is **[On]**, the width will be 8¹/₂ inches.

❖ Append CR to LF

When set to On, a carriage return will follow each line feed: CR=CR, LF=CR-LF, FF=CR-FF.

- On
- **Off**

❖ Resolution

You can set the print resolution in dots per inch.

- 300 dpi
- **600 dpi**

🔍 Reference

p.3 “Accessing User Tools (System Settings)”

PS Menu

This section describes various items of **[PS Menu]** under **[Printer Features]**.

Default settings are shown in **bold type**.

This menu appears only when the optional PostScript 3 unit is installed.

❖ Data Format

You can select a data format.

- Binary Data
- **TBCP**

This setting is not effective when operating the machine with a parallel or EtherTalk connection.

When operating the machine with a parallel connection, and also if the binary data is sent from the printer driver, the print job is canceled.

When operating the machine with an Ethernet connection, the print job is canceled under the following conditions;

- The printer driver data format is TBCP, and the data format selected on the display panel is Binary Data.
- The printer driver data format is binary, and the data format selected on the display panel is TBCP.

❖ Resolution

You can set the print resolution in dots per inch.

- 300 dpi
- **600 dpi**
- 1200 dpi

Reference

p.3 “Accessing User Tools (System Settings)”

PDF Menu

This section describes various items of **[PDF Menu]** under **[Printer Features]**. Default settings are shown in **bold type**.

❖ **Change PDF Password**

Set the password for the PDF file executing PDF Direct Print.

- Current Password
- New Password
- Confirm New Password

A password can be set using on the Web Image Monitor, but in this case the password information is sent through the network. If security is a priority, set the password using this menu from the Control Panel.

❖ **PDF Group Password**

Set the group password already specified with DeskTopBinder Lite.

- Current Password
- New Password
- Confirm New Password

A password can be set using on the Web Image Monitor, but in this case the password information is sent through the network. If security is a priority, set the password using this menu from the Control Panel.

❖ **Resolution**

You can set the print resolution in dots per inch.

- 300 dpi
- **600 dpi**
- 1200 dpi

Reference

p.3 “Accessing User Tools (System Settings)”

5. Scanner Features

This chapter describes various items of **[Scanner Features]** available in this machine.

General Settings

This section describes various items of **[General Features]** under **[Scanner Features]**. Default settings are shown in **bold type**.

❖ **Switch Title**

Sets index to use when the list of receivers from the machine is displayed.

❖ **Update Delivery Server Destination List**

Press **[Update Delivery Server Destination List]** to update the receivers from the delivery server. To use this function, it is necessary to set **[Delivery Option]** to **[On]**.

❖ **Search Destination**

Select an object receiver to search in the default state from the address book of this machine or from LDAP server.

To search from LDAP server, it is necessary to register the LDAP server in **[System Settings]** and set **[LDAP Search]** to **[On]**.

❖ **TWAIN Standby Time**

When the machine is being used to send e-mail or a file, or functioning as Document Server or a network delivery scanner, a scanning request to the machine as a TWAIN scanner will switch the machine to the network TWAIN scanner function. This setting determines the delay until the machine switches to the network TWAIN scanner function.

• **Set Time: 10 second(s)**

When **[Set Time]** is selected, you can enter the delay time with the number keys (3-30 seconds). The machine will switch to the network TWAIN scanner function when the time set here passes after the last key operation.

• **Immediate**

When **[Immediate]** is selected, the machine will switch to the network TWAIN scanner function at once.

❖ **Destination List Display Priority 1**

Select a destination list to be displayed when the machine is in the initial state. You can select either **[E-mail / Folder]** or **[Delivery Server]**.

• **E-mail / Folder**

• **Delivery Server**

❖ **Destination List Display Priority 2**

In the machine's address book, select which address book appears by default. You can select either **[E-mail Address]** or **[Folder]**.

- **E-mail Address**
- **Folder**

❖ **Print & Delete Scanner Journal**

Up to 100 transmission/delivery results can be checked on this machine. If the stored transmission/ delivery results reach 100, select whether to print the delivery journal.

- **On**
The transmission/delivery journal is printed automatically. The printed journal is deleted.
- **Off**
Transmission/delivery results are deleted one by one as new results are stored.
- **Do not Print: Disable Send**

Transmission/delivery cannot be performed when the journal is full. When printed, all records are deleted after printing. When not printed, records over the limit are automatically deleted in succession from the oldest record.

While the journal is being printed, files with the status waiting cannot be sent.

❖ **Print Scanner Journal**

The scanner journal is printed and deleted.

❖ **Delete Scanner Journal**

The scanner journal is deleted without being printed.

 **Reference**

p.3 "Accessing User Tools (System Settings)"

Scan Settings

This section describes various items of **[Scan Settings]** under **[Scanner Features]**. Default settings are shown in **bold type**.

❖ **Wait Time for Next Orig.: Exposure Glass**

When dividing originals and scanning them individually with the exposure glass to form a single file, select **[Continuous Wait]**, **[Off]**, or **[Set Wait Time]** for the waiting status.

- Continuous Wait
- Off
- **Set Wait Time: 60 second(s)**

If you select **[SADF]** in **[Original Feed Type]** on the Scan to Folder screen, the **[Wait Time for Next Orig.: Exposure Glass]** setting becomes invalid.

If you select **[Batch]** in **[Original Feed Type]** on the Scan to Folder screen, the **[Wait Time for Next Orig.: Exposure Glass]** setting becomes invalid, and the machine waits for an additional original to be put in place.

If **[Set Wait Time]** is selected, enter the wait time in seconds (3-999) for placing additional originals with the number keys. Scanning will start if additional originals are placed and the **[Start]** key is pressed within this time. You can end scanning and begin transmission by pressing the **[#]** key within this time. Once the specified time has elapsed, transmission starts automatically.

If **[Continuous Wait]** is selected, the machine will wait for additional originals until the **[#]** key is pressed. Scanning will start when additional originals are placed and the **[Start]** key is pressed. You can end scanning and begin sending by pressing the **[#]** key.

If originals are placed in the auto document feeder (ADF), transmission will start without waiting for additional originals after all originals in the ADF have been scanned, regardless of the specified settings.

If a paper misfeed occurs or any of the following operations is performed while the machine is waiting for additional originals, the countdown stops and does not start again until the **[#]** key is pressed.

- Changing the settings such as the scan settings
- Opening the upper cover of the ADF
- Pressing the **[Interrupt]** key to activate the copy mode

❖ Wait Time for Next Original(s): SADF

When dividing originals and scanning them separately with the ADF to form a single file, select **[Set Wait Time]** or **[Continuous Wait]** for the waiting status.

- Continuous Wait
- **Set Wait Time: 60 second(s)**

This setting is valid if **[SADF]** is specified for **[Original Feed Type]** when scanning.

If **[Set Wait Time]** is selected, enter the wait time in seconds (3-999) for placing additional originals with the number keys. Scanning will start automatically if additional originals are placed within this time. You can end scanning and begin transmission by pressing the **[#]** key within this time. Once the specified time has elapsed, transmission starts automatically.

If **[Continuous Wait]** is selected, the machine will wait for the additional originals until the **[#]** key is pressed. Scanning will start when additional originals are placed and the **[Start]** key is pressed. You can end scanning and begin sending by pressing the **[#]** key.

Even if originals are placed on the exposure glass, the machine will operate according to the specified settings. However, every time originals are placed on the exposure glass, you must press the **[Start]** key to start scanning. Scanning will start if additional originals are placed and the **[Start]** key is pressed within this time. You can end scanning and begin transmission by pressing the **[#]** key within this time. Once the specified time has elapsed, transmission starts automatically.

If originals are placed in the auto document feeder (ADF), transmission will start without waiting for additional originals after all originals in the ADF have been scanned, regardless of the specified settings.

If a paper misfeed occurs or any of the following operations is performed while the machine is waiting for additional originals, the countdown stops and does not start again until the **[#]** key is pressed.

- Changing the settings such as the scan settings
- Opening the upper cover of the ADF
- Pressing the **[Interrupt]** key to activate the copy mode

Reference

p.3 "Accessing User Tools (System Settings)"

"Batch, SADF", Scanner Reference

"Items for Specifying Scan Settings", Scanner Reference

"Setting Items for Original Feed Type", Scanner Reference

"Scanning Multiple Pages of Originals as One File", Scanner Reference

Send Settings

This section describes various items of **[Send Settings]** under **[Scanner Features]**. Default settings are shown in **bold type**.

❖ **Compression (Black & White)**

Select whether or not to compress black and white scan files.

- **On**
- Off

Compression reduces the time required for transferring the scan file. The actual time required for file transfer will vary depending on the file size and network load.

❖ **Compression (Gray Scale)**

Specify whether or not to compress multi-level (grayscale) scan files.

- **On: Compression Level 3**
- Off

If you select **[On]**, you can specify the compression level between one and five. The image quality is better for lower compression, but the time required for file transfer increases accordingly.

The actual time required for file transfer will vary depending on the file size and network load.

❖ **Max. E-mail Size**

Select whether or not to limit the size of an e-mail to which an image is attached.

- **On: 2048 KB**
- Off

When **[On]** is selected, enter the size limit (128-102400 KB) with the number keys.

When the SMTP limits the size, match that setting.

❖ **Divide & Send E-mail**

This function is effective only when **[On]** is selected for **[Max. E-mail Size]**. Select whether or not an image exceeding the size specified in **[Max. E-mail Size]** should be divided and sent using more than one e-mail.

- **Yes (per Max. Size)**
- Yes (per Page)
- No

When **[Yes (per Max. Size)]** is selected, enter the Max. Number of Divisions (2-500) with the number keys.

When **[Multi-page: TIFF]** or **[Multi-page: PDF]** is selected for **[File Type]**, the image will not be divided even if **[Yes (per Page)]** is selected.

When **[Yes (per Max. Size)]** is selected, some received files may not be able to be restored, depending on the type of e-mail software.

When **[No]** is selected, the e-mail is not sent if its size exceeds the limit, and an error message appears. The scan file is discarded.

Set the maximum e-mail size within the capacity of the SMTP server.

5

❖ **E-mail Information Language**

Select the language in which email information such as title, document name, and sender's name is sent.

Select one of the following 20 languages:

British English, American English, German, French, Italian, Spanish, Dutch, Portuguese, Polish, Czech, Swedish, Finnish, Hungarian, Norwegian, Danish, Japanese, Simplified Chinese, Traditional Chinese, Russian, and Hangul. The e-mail text which is a template cannot be changed.

❖ **No. of Digits for Single Page Files**

Sets digit number for serial number to attach to Single Page file name.

- **4 Digits**
- 8 Digits

❖ **Stored File E-mail Method**

Specify the e-mail setting for sending stored files. You can select **[Send File]** or **[Send URL Link]**. This setting can be used for the following:

- **Send File**
- Send URL Link

If you select **[Send File]**, actual files are attached to e-mails.

If you select **[Send URL Link]**, URL Links to file locations are attached to e-mails.

🔍 **Reference**

p.3 "Accessing User Tools (System Settings)"

6. Registering Addresses and Users for Scanner Functions

Following describes the procedure for registering the destination and the user.

Address Book

Registering information such as the names of users and their e-mail addresses in the Address Book allows you to manage them easily.

❗ Important

- ❑ Address Book data is stored on the hard disk. It can be lost if there is some kind of hard disk failure. The manufacturer shall not be responsible for any damages resulting data loss.

You can register and manage the following items in the Address Book:

❖ Names

You can register the name of the user and the key display. This is the basic information required for managing user of the machine.

To register e-mail address in the address book, you must register information such as the user name and destination name in advance.



❖ Auth. Info

You can register user codes in order to restrict particular functions to certain users, and to check their use of each function. You can also register login user names and login passwords to be used when sending e-mail, sending to folders, or accessing an LDAP server.

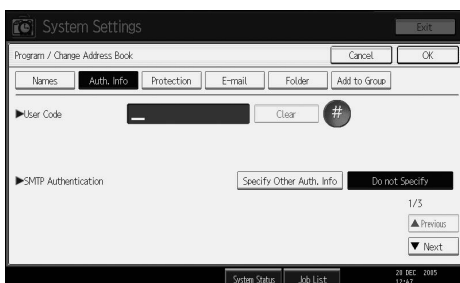

❖ **Protection**

You can set protection codes to stop sender's name from being used or folders from being accessed without authorization.

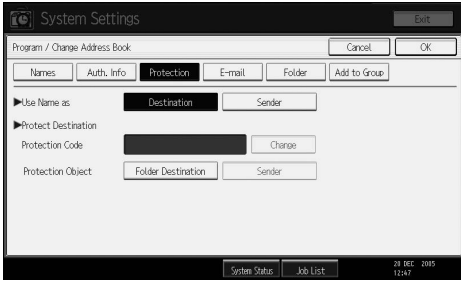

❖ **E-mail Address**

You can register e-mail destinations in the Address Book.

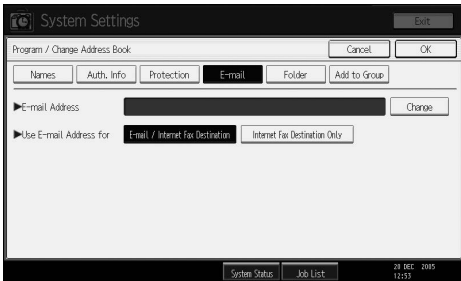

6

❖ **Folder**

You can register the protocol, path name and server name.

- SMB

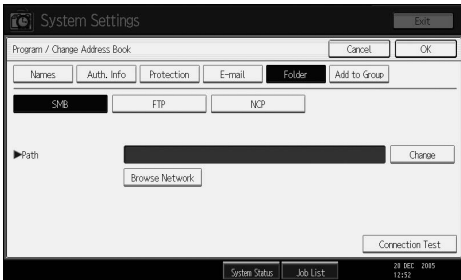

- FTP

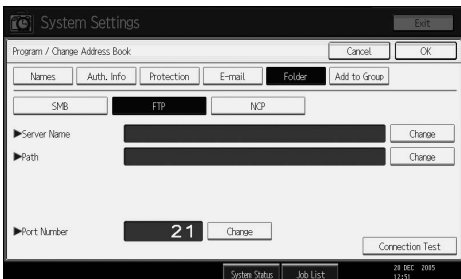

- NCP

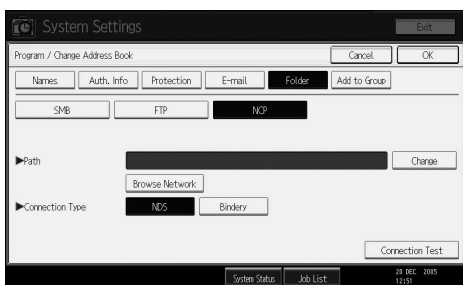

❖ Add to Group

You can put registered e-mail and folder destinations into a group for easier management.

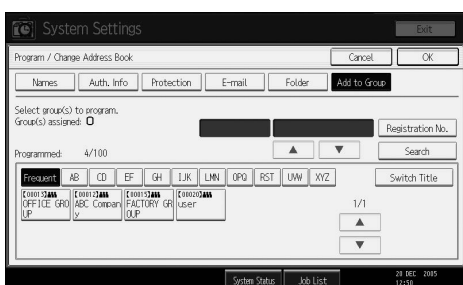

Note

- ❑ You can also use a Web Image Monitor to register names in the Address Book. With the SmartDeviceMonitor for Admin, you can register multiple names at the same time.
- ❑ Using **[Address Management Tool]** in SmartDeviceMonitor for Admin, you can backup Address Book data. We recommend backing up data when using the Address Book.
- ❑ For details about using Web Image Monitor, see the Web Image Monitor Help.
- ❑ For operating instructions, see SmartDeviceMonitor for Admin Help.

Reference

p.3 “Accessing User Tools (System Settings)”

Managing names in the Address Book

By registering a name and key display beforehand, you can specify email and folder destinations simply by selecting the name key.

Reference

p.163 “Registering Names”

Sending e-mail by Quick Dial

You can also specify an e-mail address by selecting the destination shown on the initial scanner display when sending a document using the scanner function. A registered e-mail address can be used as the sender's address, and the sender's address are automatically entered in the "From" field of an email header.

 **Reference**

p.177 "E-mail Destination"

Sending scanned files to a shared folder directly

After registering the path name, user name and password, you can connect to a shared folder simply by selecting the destination shown on the initial scanner display whenever sending files using the scanner function to a shared folder.

To share the folder using Windows, select the SMB protocol.

To register the folder to the FTP server, select the FTP protocol.

To register the folder to the NetWare server, select the NCP protocol.

 **Reference**

p.181 "Registering Folders"

Preventing unauthorized user access to shared folders from the machine

After registering a protection code, you can specify the object of protection to prevent an e-mail destination from being used without permission.

You can prevent unauthorized access to registered folders.

 **Reference**

p.209 "Registering a Protection Code"

Managing users and machine usage

Register user codes to limit users to the following functions and check their use of each function:

- Copier
- Document Server
- Scanner
- Printer

 **Reference**

p.167 "Authentication Information"

Registering Names

Register user information including their names.

The user name is useful for selecting a destination when sending e-mail. You can also use it as a folder destination.

You can register up to 2000 names.

Reference

p.3 “Accessing User Tools (System Settings)”

Registering Names

Following describes the procedure for registering names.

1 Press [System Settings].

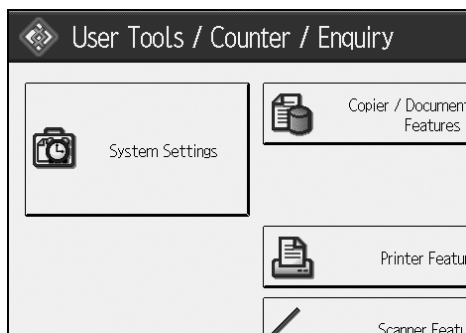

2 Press [Administrator Tools].

3 Press [Address Book Management].

4 Check that [Program / Change] is selected.

5 Press [New Program].

6 Press [Change] on the right of the Name.

The name entry display appears.

7 Enter the name, and then press [OK].

8 Press the key for the classification you want to use under Select Title.

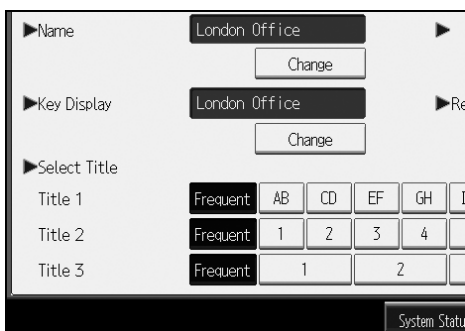

9 Press [OK] twice.

10 Press the [User Tools/Counter] key.

Note

- The name can be used for documents in the Document Server. For details about the Document Server.
- The keys you can select are as follows:
 - **[Frequent]**: Added to the page that is displayed first.
 - **[AB], [CD], [EF], [GH], [IJK], [LMN], [OPQ], [RST], [UVW], [XYZ], [1] to [10]**: Added to the list of items in the selected title.
- You can select **[Frequent]** and one more page for each title.

Reference

"Entering Text", About This Machine

"Document Server", Copy/ Document Server Reference

Changing a Registered Name

Following describes the procedure for changing a name

- 1 Press [System Settings].

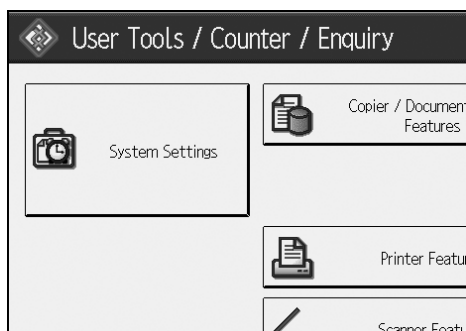

- 2 Press [Administrator Tools].
- 3 Press [Address Book Management].
- 4 Check that [Program / Change] is selected.
- 5 Select the registered name you want to change.

Press the name key, or enter the registered number using the number keys.

- 6 To change the name or key display, press [Change] on the right of the name or key display.
- 7 Enter the name or key display, and then press [OK].
- 8 To change the title, press the key for the classification you want to use from Select Title.

Note

- You can search by the registered name, user code, folder name, or e-mail address.

Reference

"Entering Text", About This Machine

To change a registration number

- 1 Press [Change] to the right of "Registration No."
- 2 Enter a new registration number using the number keys, and then press the [#] key.

Deleting a Registered Name

Following describes the procedure for deleting a user.

- 1** Press [System Settings].

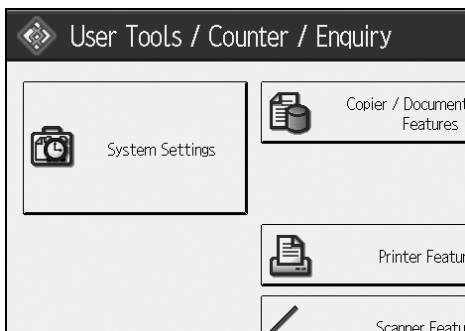

- 2** Press [Administrator Tools].

- 3** Press [Address Book Management].

- 4** Press [Delete].

- 5** Select the name you want to delete.

Press the name key, or enter the registered number using the number keys.

- 6** Press [Yes].

- 7** Press [Exit].

- 8** Press the [User Tools/Counter] key.

Authentication Information

Following describes the procedure for authenticating a user code.

Important

- The functions associated with each user code are the same. If you change or delete user codes, management data and limits associated with that code become invalid.

Register user codes to limit users to the following functions and check their use of each function:

Copier

Document Server

Scanner

Printer

Note

- You can register up to 500 user codes.
- The number of copies scanned using the scanner function is counted for each user code. This allows you to check each user's usage.
- To automatically register the printer driver user code, select **[Printer: PC Control]** for the printer in User Code Authentication. To use the user code set in User Tools, set the user codes registered in User Tools for the printer driver.
- For details about setting user codes for the printer driver, see Printer Driver Help.

Reference

p.3 "Accessing User Tools (System Settings)"

p.76 "User Authentication Management"

Registering a User Code

Following describes the procedure for registering a user code.

- 1 Press **[System Settings]**.

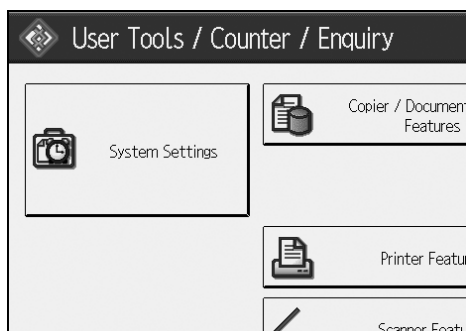

- 2 Press **[Administrator Tools]**.
- 3 Press **[Address Book Management]**.
- 4 Check that **[Program / Change]** is selected.
- 5 Press the name whose code is to be registered, or enter the registered number using the number key.
You can search by the registered name, user code, folder name, or e-mail address.
- 6 Press **[Auth. Info]**.
- 7 Enter the user code using the number keys, and then press **[#]** key.

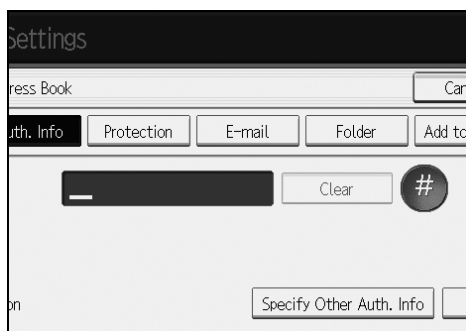

If you make a mistake, press **[Clear]** or the **[Clear/Stop]** key.

- 8 Press **[▼Next]** twice.

- 9** Select the functions to be used with the user code from Available Functions.

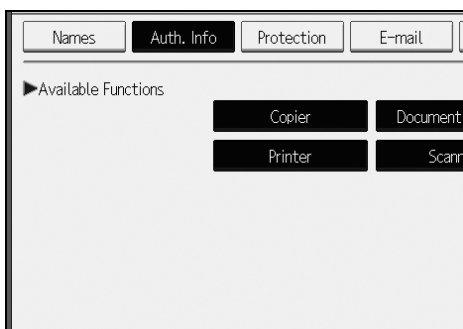

- 10** Press [OK].
- 11** Press [Exit].
- 12** Press the [User Tools/Counter] key.

Note

- User codes can contain up to eight digits.
- To register the name, see "Registering Names".

Reference

p.163 "Registering Names"

Changing a User Code

Following describes the procedure for changing a registered use code.

Important

- Even if you change a user code, the counter value will not be cleared.

- 1** Press [System Settings].

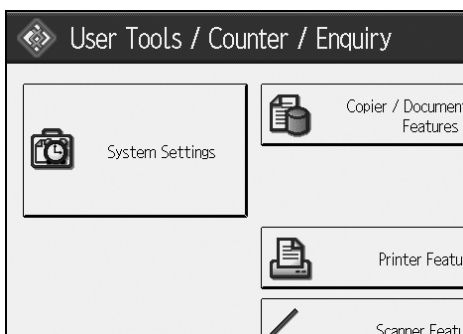

- 2** Press [Administrator Tools].
- 3** Press [Address Book Management].
- 4** Check that [Program / Change] is selected.

5 Select the user whose user code you want to change.

Press the name key, or enter the registered number using the number keys.

You can search by the registered name, user code, folder name, or e-mail address.

6 Press [Auth. Info].

7 Press [Change], and then enter the new user code using the number keys.



8 Press [#] key.

9 To change the available functions, press [Auth. Info] and then press [▼Next] twice.

10 Press the key to select the functions to enable them.

Press the key to highlight it, and then the function is enabled. To cancel a selection, press the highlighted key.

11 Press [OK].

12 Press [Exit].

13 Press the [User Tools/Counter] key.

Note

To change the name, key display and title, see “Changing a Registered Name”.

Reference

p.165 “Changing a Registered Name”

Deleting a User Code

Following describes the procedure for deleting a user code

Important

- After clearing the user code, the counter is automatically cleared.

1 Press [System Settings].

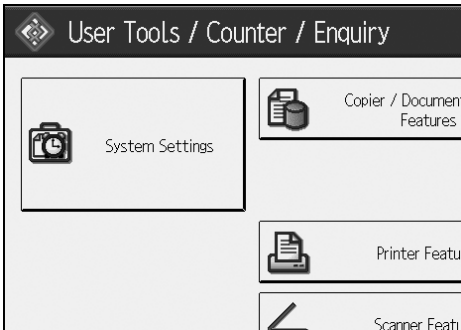

2 Press [Administrator Tools].

3 Press [Address Book Management].

4 Check that [Program / Change] is selected.

5 Select the name whose code is to be deleted.

Press the name key, or enter the registered number using the number keys.

You can search by the registered name, user code, folder name, or e-mail address.

6 Press [Auth. Info].

7 Press [Change] to delete the user code, and then press [#] key.

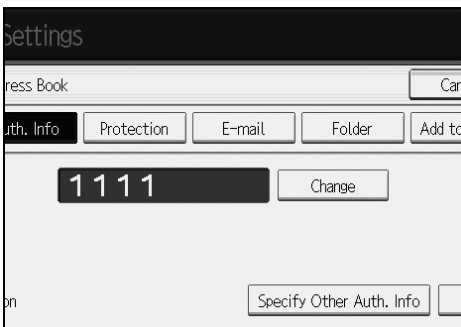

8 Press [OK].

9 Press [Exit].

10 Press the **[User Tools/Counter]** key.

Note

- To delete a name from the Address Book entirely, see “Deleting a Registered Name”.

Reference

p.166 “Deleting a Registered Name”

Displaying the Counter for Each User

Following describes the procedure for displaying the counter on individual user basis.

1 Press **[System Settings]**.

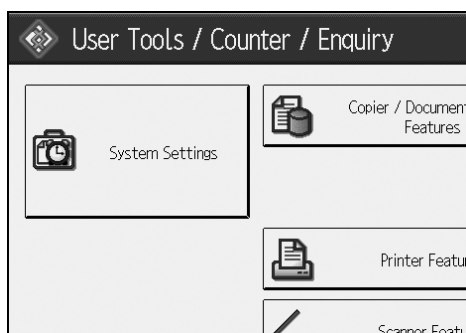

2 Press **[Administrator Tools]**.

3 Press **[Display / Clear / Print Counter per User]**.

4 Select the function usage you want to print from **[Copier Counter]**, **[Print Counter]**, or **[Scanner Counter]**.

Counters for individual function usage under each user code appear.

Printing the Counter for Each User

Following describes the procedure for printing the counter that counts on individual user basis.

- 1 Press **[System Settings]**.

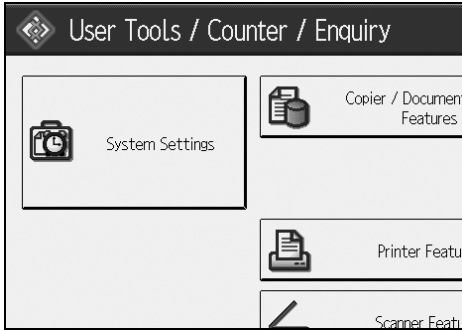

- 2 Press **[Administrator Tools]**.

- 3 Press **[Display / Clear / Print Counter per User]**.

- 4 Select a user code from the left side of the display.

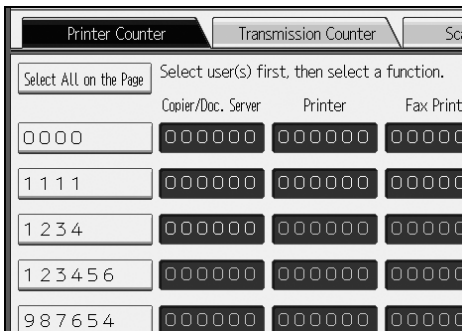

Press **[Select All on the Page]** to select all user codes on the page.

- 5 Press **[Print Counter List]** under Per User.

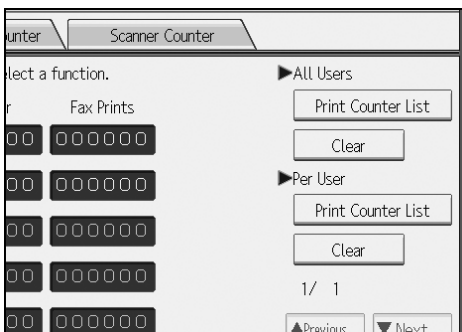

Enter the user code, and then press **[#]** if the user code is registered.

6 Select the function usage you want to print from [Copier Counter], [Print Counter], and [Scanner Counter].

7 Press [Print].

Printing the Counter for All User

Following describes the procedure for printing the counter for all users.

1 Press [System Settings].

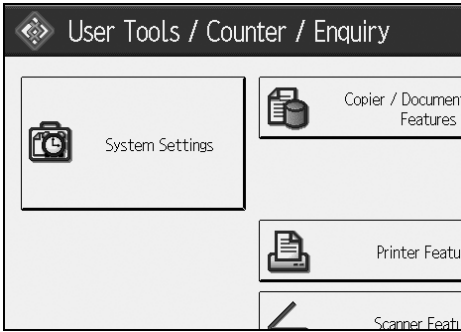

2 Press [Administrator Tools].

3 Press [Display / Clear / Print Counter per User].

4 Press [Print Counter List] under All Users.

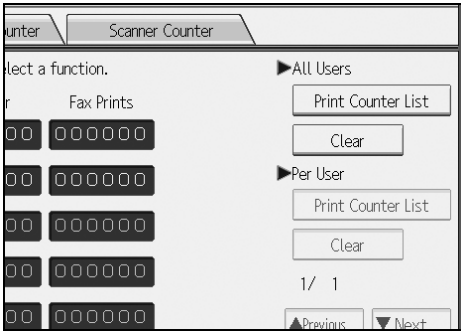

Enter the user code, and then press [#] if the user code is registered.

5 Select the function usage you want to print from [Copier Counter], [Print Counter], and [Scanner Counter].

6 Press [Print].

Clearing the Number of Prints

Following describes the procedure for clearing the counter.

- 1 Press [System Settings].



- 2 Press [Administrator Tools].

- 3 Press [Display / Clear / Print Counter per User].

- 4 Select the user code to clear.

- 5 To clear the number of prints made under a user code, Select the user code from the left side of the display.

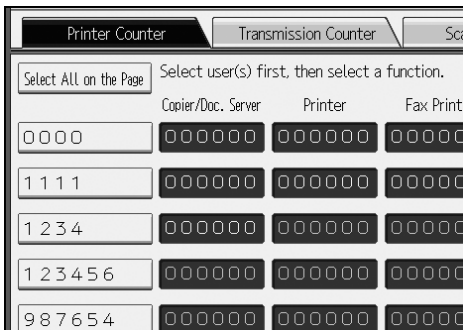

Press [Select All on the Page] to select all user codes on the page.

- 6 Press [Clear] under Per User Codes.

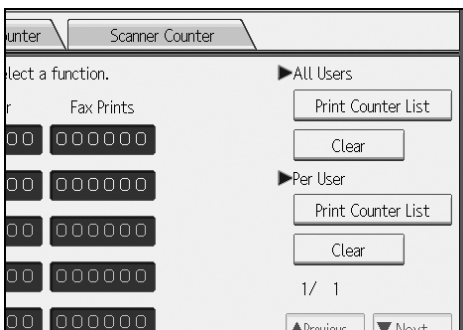

- 7** Select the function usage you want to clear from [Copier Counter], [Print Counter], [Scanner Counter], and [All Counters].
- 8** Press [OK].
- 9** To clear the number of prints for all user codes, press [Clear] under All Users.
- 10** Select the function usage you want to clear from [Copier Counter], [Print Counter], [Scanner Counter], and [All Counters].
- 11** Press [OK].

E-mail Destination

Register e-mail destinations so you do not need to enter an e-mail address every time, and can send scan files from scanner by email.

- It is easy to select the e-mail destination if you register "Name" and "Key Display" as the e-mail destination.
- You can register e-mail destinations as a group.
- You can use the e-mail address as the sender's address when sending scan files in scanner mode. If you want to do this, set a protection code on the sender address to prevent unauthorized access.

Note

- You can select an e-mail address from an LDAP server, and then register it in the Address Book. See "Sending Scan File by E-mail", Scanner Reference.

Reference

p.3 "Accessing User Tools (System Settings)"

p.209 "Registering a Protection Code"

Registering an E-mail Destination

6

- 1** Press [System Settings].

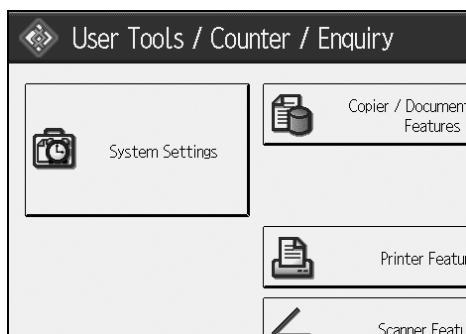

- 2** Press [Administrator Tools].
- 3** Press [Address Book Management].
- 4** Check that [Program / Change] is selected.
- 5** Select the name whose e-mail address you want to register. Press the name key, or enter the registered number using the number keys.
- 6** Press [E-mail].

7 Press [Change].



8 Enter the e-mail address.



9 Press [OK].

10 Select [E-mail].

11 Press [OK].

Note

- You can enter up to 128 characters for the e-mail address.
- To register the name, see “Registering Names”.

Reference

- p.163 “Registering Names”
- p.168 “Registering a User Code”
- p.201 “Registering Names to a Group”

Changing an E-mail Destination

- 1 Press [System Settings].

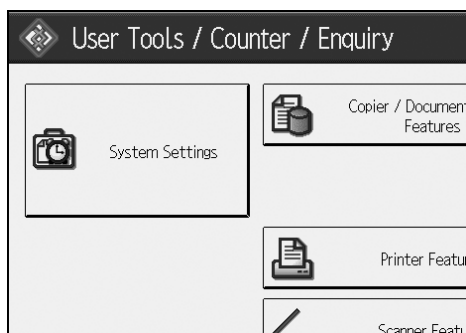

- 2 Press [Administrator Tools].
- 3 Press [Address Book Management].
- 4 Check that [Program / Change] is selected.
- 5 Select the name whose e-mail address you want to change.

Press the name key, or enter the registered number using the number keys.

You can search by the registered name, user code, folder name, or e-mail address.

- 6 Press [E-mail].
- 7 Press [Change] under E-mail Address.

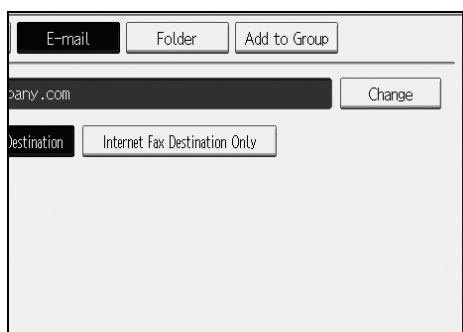

- 8 Enter the e-mail address, and then press [OK].
- 9 Press [OK].

Note

- To change the name, key display and title, see "Changing a Registered Name".

Reference

p.165 "Changing a Registered Name"
"Entering Text", About This Machine

Using the e-mail address as the sender

- 1** Press [Protection].
- 2** Press [Sender] under [Use Name as].

Deleting an E-mail Destination

- 1** Press [System Settings].

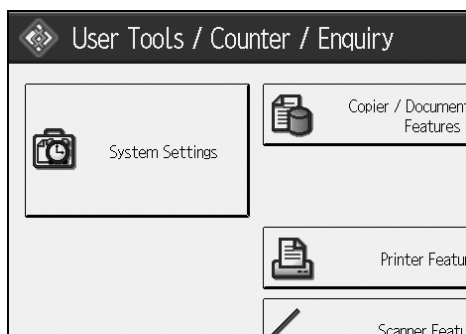

- 2** Press [Administrator Tools].
- 3** Press [Address Book Management].
- 4** Press [Delete].
- 5** Select the name whose e-mail address you want to delete.

Press the name key, or enter the registered number using the number keys.
You can search by the registered name, user code, folder name, or e-mail address.

- 6** Press [E-mail].
- 7** Press [Change] under E-mail Address.
- 8** Press [Delete All].
- 9** Press [OK] twice.
- 10** Press the [User Tools/Counter] key.

Note

- To delete the name, key display, and title, see "Deleting a Registered Name".

Reference

p.166 "Deleting a Registered Name"

Registering Folders

By registering a shared folder, you can send scan files to it directly.

There are three types of protocol you can use:

- SMB
For sending files to shared Windows folders.
- FTP
Use when sending files to an FTP server.
- NCP
Use when sending files to an Net- Ware server.

Note

- For details about protocols, server names, and folder levels, consult your network administrator.
- You can prevent unauthorized users from accessing folders from the machine. See "Registering a Protection Code".
- You can only select either SMB, FTP, or NCP. If you change protocol after finishing your settings, all previous entries are cleared.
- You can register folder destinations in a group.

Reference

p.3 "Accessing User Tools (System Settings)"

Using SMB to Connect

Note

- To register a folder in an FTP server, see "Using FTP to Connect".
- To register a folder in an NetWare server, see "Using NCP to Connect".

Reference

p.188 "Using FTP to Connect"

p.193 "Using NCP to Connect"

Registering a Folder

1 Press [System Settings].

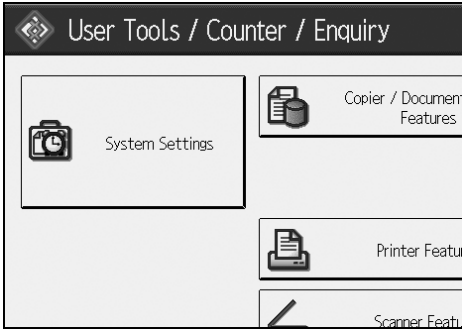

2 Press [Administrator Tools].

3 Press [Address Book Management].

4 Check that [Program / Change] is selected.

5 Select the name whose folder you want to register. Press the name key, or enter the registered number using the number keys.

6 Press [Auth. Info].

7 Press [Next].

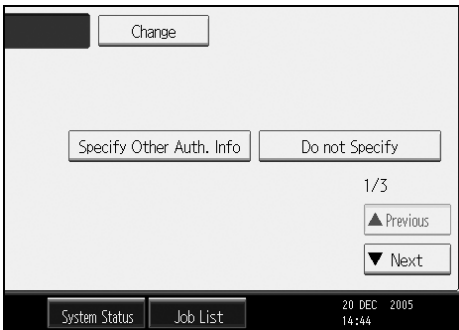

8 Press [Specify Other Auth. Info] on the right side of Folder Authentication.

9 Press [Change] under Login User Name.

10 Enter the login user name, and then press [OK].

11 Press [Change] under Login Password.

12 Enter the password, and then press [OK].

13 Enter the password again to confirm, and then press [OK].

14 Press [Folder].

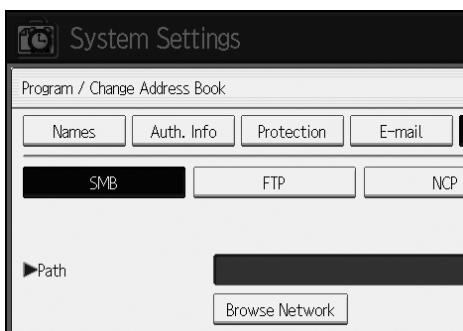
15 Press [SMB].**16** Use "Direct Specification" or "Browse Network" to specify the path.

To specify a folder, enter its path directly or select it by referring to the network. For details, see "To locate the folder manually" or "Using Browse Network to locate the folder".

17 Press [Connection Test] to check the path is set correctly.**18** Press [Exit].**19** Press [OK].**20** Press [Exit].**Note**

- To register the name, see "Registering Names".
- You can enter up to 64 characters for the user name.
- You can enter up to 64 characters for the password.
- To specify a folder, you can either enter the path manually or locate the folder by browsing the network.
- If the connection test fails, check the settings, and then try again.
- When Do not Specify is selected, the SMB User Name and SMB Password that you have specified in Default User Name / Password (Send) of File Transfer settings applies.
- If User Authentication is specified, contact your administrator.

Reference

p.163 "Registering Names"

p.184 "To locate the folder manually"

p.184 "Using Browse Network to locate the folder"

To locate the folder manually

- 1** Press **[Change]** under **Path**.
- 2** Enter the path where the folder is located.
- 3** Press **[OK]**.

If the format of the entered path is not correct, a message appears. Press **[Exit]**, and then enter the path again.

 **Note**

- Enter the path using this format: “\ServerName\Share-Name\PathName”.
- You can also enter an IPv4 address.
- You can enter a path using up to 128 characters.

Using Browse Network to locate the folder

- 1** Press **[Browse Network]**.
Work groups on the same network are displayed.
Network display only lists client computers you are authorized to access.
- 2** Select the work group.
Computers in the selected work group are displayed.
- 3** Select a client computer.
Shared folders under it appear.

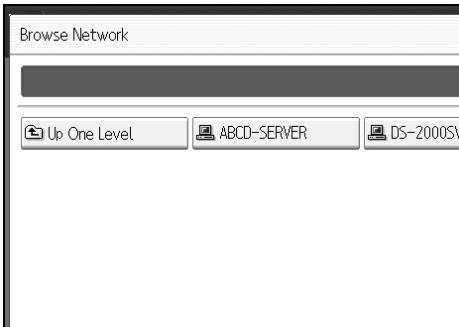

You can press **[Up One Level]** to switch between levels.

- 4** Select the folder you want to register.
- 5** **[OK]**.

If a Login Screen Appears

This section explains how to log on to the machine if the login screen appears when you try to access a folder by browsing the network.

If you have not specified folder authentication, or if an incorrect user name or password has been entered for folder authentication, the login screen appears.

1 Enter the login user name, and then press [OK].

Enter the login user name specified for folder authentication.

2 Enter the password, and then press [OK].

The path to the selected folder appears.

If a message appears, press [Exit], and then enter the login user name and password again.

Changing a Folder

1 Press [System Settings].

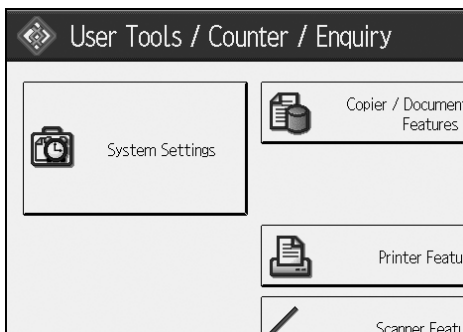

2 Press [Administrator Tools].

3 Press [Address Book Management].

4 Check that [Program / Change] is selected.

5 Select the name whose folder you want to change.

Press the name key, or enter the registered number using the number keys.

You can search by the registered name, user code, folder name, or e-mail address.

6 Press [Folder].

7 Select the items you want to change.

When specifying a folder, enter the path directly or select it by referencing the network. For more information, see "To locate the folder manually" and "Using Browse Network to locate the folder".

8 Press [Connection Test] to check the path is set correctly.

9 Press [OK].

10 Press [Exit].

 **Note**

To change the name, key display and title, see “Changing a Registered Name”.

 **Reference**

p.165 “Changing a Registered Name”

To change the protocol

1 Press [FTP] or [NCP].

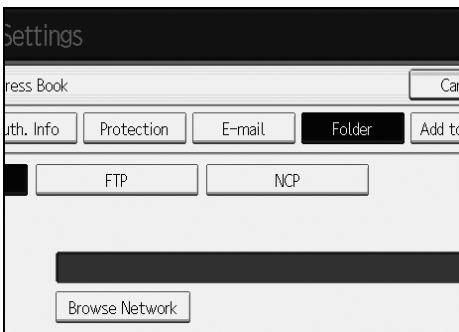

2 A confirmation message appears. Press [Yes].

Changing the protocol will clear all settings made under the previous protocol.

3 Enter each item again.

 **Reference**

p.188 “Registering a Folder”

Changing SMB settings

To change SMB settings:

1 Press [Change] of path name.

2 Enter the name of the path on which the folder is located, and then press [OK].

 **Note**

The folder destination can be selected using Network Reference.

 **Reference**

p.184 “Using Browse Network to locate the folder”

Deleting a registered folder

1 [System Settings].

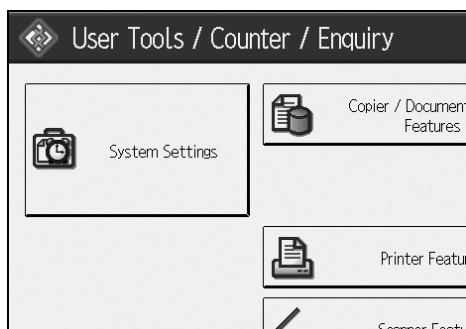

2 Press [Administrator Tools].

3 Press [Address Book Management].

4 Press [Delete].

5 Select the name whose folder you want to delete.

Press the name key, or enter the registered number using the number keys.

You can search by the registered name, user code, folder name, or e-mail address.

6 Press [Folder].

7 Press the protocol which is not currently selected.

A confirmation message appears.

8 Press [Yes].

9 Press [OK].

10 Press [Exit].

Note

- To delete the name, key display, and title, see "Deleting a Registered Name".

Reference

p.166 "Deleting a Registered Name"

Using FTP to Connect

Note

- ❑ To register a shared folder configured in Windows, see “Using SMB to Connect”.
- ❑ To register a folder in an NetWare server, see “Using NCP to Connect”.

Reference

p.181 “Using SMB to Connect”

p.193 “Using NCP to Connect”

Registering a Folder

- 1** Press [System Settings].

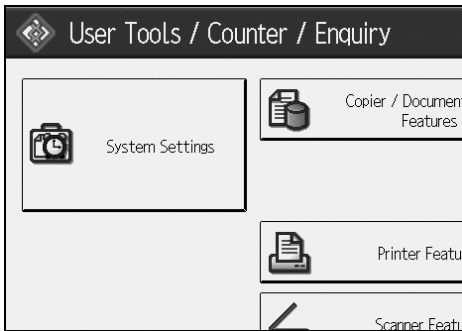

- 2** Press [Administrator Tools].

- 3** Press [Address Book Management].

- 4** Check that [Program / Change] is selected.

- 5** Select the name whose folder you want to register.

You can search by the registered name, user code, folder name, or e-mail address.

- 6** Press [Auth. Info], and then press [Next].

- 7** Press [Specify Other Auth. Info] on the right side of Folder Authentication.

- 8** Press [Change] under Login User Name.

- 9** Enter the login user name, and then press [OK].

- 10** Press [Change] under Login Password.

- 11** Enter the password, and then press [OK].

- 12** Enter the password again to confirm, and then press [OK].

- 13** Press [Folder].

14 Press [FTP].

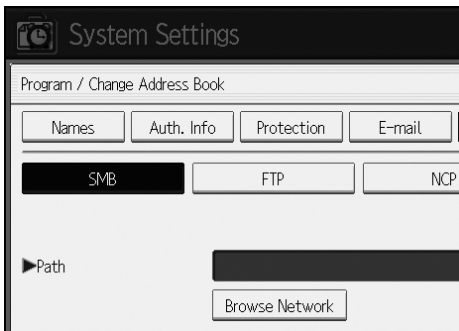

15 Press [Change] under Server Name.

16 Enter the server name, and then press [OK].

17 Press [Change] under Path.

18 Enter the path.

19 Press [OK].

20 Press [Change] under "Port No."

21 Enter Port No..

22 Press [Connection Test] to check the path is set correctly.

23 Press [Exit].

24 Press [OK].

25 Press [Exit].

 **Note**

- To register the name, see "Registering Names".
- You can enter up to 64 characters for the user name.
- You can enter up to 64 characters for the password.
- You can enter a server name using up to 64 characters.
- You can enter an absolute path, using this format: "/user/ home/user-name"; or a relative path, using this format: "directory/sub-directory".
- If you leave the path blank, the login directory is assumed to be the current working directory.
- You can also enter an IPv4 address.
- You can enter a path using up to 128 characters.
- To change the port number, press [Change] under Port No.. Enter the port number using the number keys, and then press [#].
- Specify the port number within the range of 1 to 65535.

- If the connection test fails, check the settings, and then try again.
- When **[Do not Specify]** is selected, the FTP User Name and FTP Password that you have specified in Default User Name / Password (Send) of File Transfer settings applies. For details, see "File Transfer".
- If User Authentication is specified, contact your administrator.

 **Reference**

p.163 "Registering Names"

p.184 "To locate the folder manually"

p.184 "Using Browse Network to locate the folder"

Changing a Folder

1 Press **[System Settings]**.

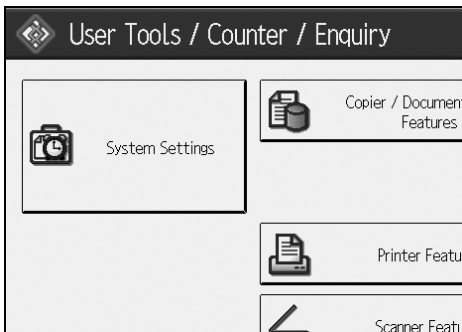

2 Press **[Administrator Tools]**.

3 Press **[Address Book Management]**.

4 Check that **[Program / Change]** is selected.

5 Select the name whose folder you want to change, and then press **[Folder]**.

Press the name key, or enter the registered number using the number keys.

You can search by the registered name, user code, folder name, or e-mail address.

6 Press **[Folder]**.

7 Select the items you want to change.

8 Press **[Connection Test]** to check the path is set correctly.

9 Press **[OK]**.

10 Press **[Exit]**.

Note

- To change the name, key display and title, see “Changing a Registered Name”.

Reference

p.165 “Changing a Registered Name”

To change the protocol

- 1** Press [SMB], or [NCP].

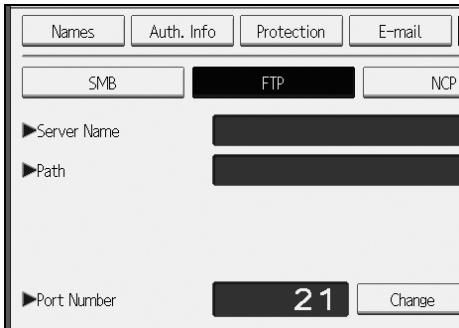

- 2** A confirmation message appears. Press [Yes].

Changing the protocol will clear all settings made under the previous protocol.

- 3** Enter each item again.

Reference

p.182 “Registering a Folder”

Changing items under FTP

- 1** Press [Change] under Port No.
- 2** Enter the new port number, and then press [#].
- 3** Press [Change] under Server Name.
- 4** Enter the new server name, and then press [OK].
- 5** Press [Change] under “Path”.
- 6** Enter the new path, and then press [OK].

Deleting a Folder

1 Press [System Settings].

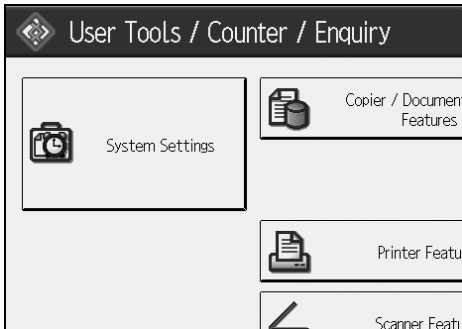

2 Press [Administrator Tools].

3 Press [Address Book Management].

4 Press [Delete].

5 Select the name whose folder you want to delete.

Press the name key, or enter the registered number using the number keys.

You can search by the registered name, user code, folder name, or e-mail address.

6 Press [Folder].

7 Press the protocol which is not currently selected.

A confirmation message appears.

8 Press [Yes].

9 Press [OK].

10 Press [Exit].

 **Note**

- To delete a name entirely, see “Deleting a Registered Name”.

 **Reference**

p.166 “Deleting a Registered Name”

Using NCP to Connect

Note

- ❑ To register a shared folder configured in Windows, see “Using SMB to Connect”
- ❑ To register a folder in an FTP server, see “Using FTP to Connect”

Reference

p.181 “Using SMB to Connect”

p.188 “Using FTP to Connect”

Registering a Folder

- 1** Press [System Settings].

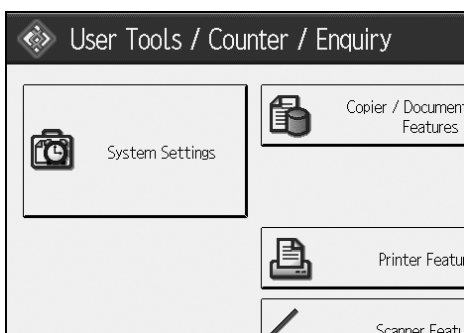

- 2** Press [Administrator Tools].
- 3** Press [Address Book Management].
- 4** Check that [Program / Change] is selected.
- 5** Press the name you want to register or enter the registered number using the number keys.
You can search by the registered name, user code, folder name, or e-mail address.
- 6** Press [Auth. Info], and then press [Next].
- 7** Press [Specify Other Auth. Info] on the right side of Folder Authentication.
- 8** Press [Change] under Login User Name.
- 9** Enter the login user name, and then press [OK].
- 10** Press [Change] under Login Password.
- 11** Enter the password, and then press [OK].
- 12** Enter the password again to confirm, and then press [OK].
- 13** Press [Folder].

14 Press **[NCP]**.

15 Select "Connection Type".

If you want to specify a folder in an NDS tree, press **[NDS]**. If you want to specify a folder on a NetWare server, press **[Bindery]**.

16 Specify the folder.

17 Press **[OK]**.

18 Press **[Exit]**.

 **Note**

- To register the name, see "Registering Names".
- You can enter up to 64 characters for the user name.
- If you have set "Connection Type" to **[NDS]**, enter the user name followed by the name of the context where the user object is located. If the user name is "user" and the context name is "context", enter "user.context"
- You can enter up to 64 characters for the password.
- To specify a folder, you can either enter the path manually or locate the folder by browsing the network.
- When **[Do not Specify]** is selected, the NCP User Name and NCP Password that you have specified in Default User Name / Password (Send) of File Transfer settings applies. For details, see "File Transfer".
- If User Authentication is specified, contact your administrator.

 **Reference**

- p.163 "Registering Names"
- p.195 "To locate the folder manually"
- p.195 "Using Browse Network to locate the folder"
- "Entering Text", About This Machine

To locate the folder manually

- 1** Press **[Change]** under **Path**.
- 2** Enter the path where the folder is located.
- 3** **[OK]**.
- 4** Press **[Connection Test]** to check the path is set correctly.
- 5** Press **[Exit]**.

 **Note**

- If you set "Connection Type" to **[NDS]**, and if the NDS tree name is "tree", the name of the context including the volume is "context", the volume name is "volume" and the folder name is "folder", then the path will be "\\tree\volume.context\folder".
- If you set "Connection Type" to **[Bindery]**, and if the Net-Ware server name is "server", the volume name is "volume" and the folder name is "folder", then the path will be "\\server\volume\folder".
- You can enter a path using up to 128 characters.
- If the connection test fails, check the settings, and then try again.

Using Browse Network to locate the folder

- 1** Press **[Browse Network]**.
- 2** If you have set "Connection Type" to **[NDS]**, a list of items in the NDS tree appears. If you have set "Connection Type" to **[Bindery]**, a list of items on the NetWare server appears.
- 3** Search for the destination folder in the NDS tree or NetWare server.
You can press **[Up One Level]** to switch between levels.
- 4** Select the folder you want to register.
- 5** **[OK]**.

 **Note**

- Only the folders you are allowed to access appear in **[Browse Network]**.
- If the languages used on the machine and the destination you want to view differ, the items in the list may not appear correctly.
- Up to 100 items can be displayed in the list.

Changing a registered folder

1 Press **[System Settings]**.

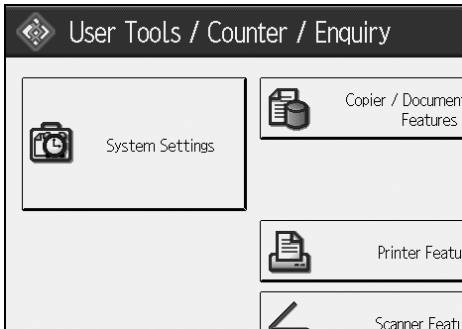

2 Press **[Administrator Tools]**.

3 Press **[Address Book Management]**.

4 Check that **[Program / Change]** is selected.

5 Select the user of the registered folder you want to change.

Press the name key, or enter the registered number using the number keys.

You can search by the registered name, user code, folder name, or e-mail address.

6 Press **[Folder]**.

7 Select **"Connection Type"**.

If you want to specify a folder in an NDS tree, press **[NDS]**. If you want to specify a folder on a NetWare server, press **[Bindery]**.

8 Specify the folder.

To specify a folder, you can either enter the path manually or locate the folder by browsing the network.

9 Press **[Connection Test]** to check the path is set correctly.

10 Press **[OK]**.

11 Press **[Exit]**.

 **Note**

To change the name, key display and title, see "Changing a Registered Name".

 **Reference**

p.165 "Changing a Registered Name"

Changing NCP settings

To change NCP settings:

- 1** Select the type of connection.
- 2** Press [Change] of path name.
- 3** Enter the name of the path on which the folder is located, and then press [OK].
- 4** Press [Connection Test] to make sure the path is correctly set up.
- 5** When you have made the necessary changes to the information, press [Set].
- 6** Press [OK].

 **Note**

- To specify a folder, enter its path directly or select it using Browser Network.

 **Reference**

p.195 "To locate the folder manually"

p.195 "Using Browse Network to locate the folder"

To change the protocol

- 1** Press [SMB], or [FTP].
- 2** A confirmation message appears. Press [Yes].
Changing the protocol will clear all settings made under the previous protocol.
- 3** Enter each item again.

 **Reference**

p.182 "Registering a Folder"

p.188 "Registering a Folder"

Deleting a Folder

- 1** Press **[System Settings]**.

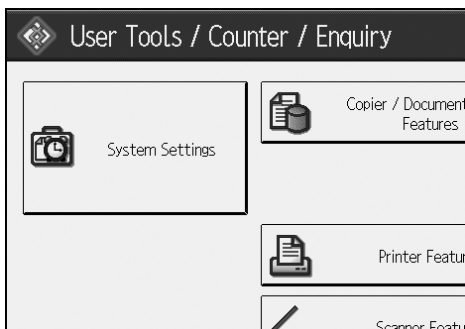

- 2** Press **[Administrator Tools]**.

- 3** Press **[Address Book Management]**.

- 4** Press **[Delete]**.

- 5** Select a user of the folder you want to delete.

Press the name key, or enter the registered number using the number keys.

You can search by the registered name, user code, folder name, or e-mail address.

- 6** Press **[Folder]**.

- 7** Press the protocol which is not currently selected.

A confirmation message appears.

- 8** Press **[Yes]**.

- 9** Press **[OK]**.

- 10** **[Exit]**.

 **Note**

- To delete a name entirely, see “Deleting a Registered Name”.

 **Reference**

p.166 “Deleting a Registered Name”

Registering Names to a Group

You can register names to a group to enable easy management of e-mail addresses and folders for each group.

To add names to a group, the groups must be registered beforehand.

Important

- When using Scan to Folder function, you cannot send scan files to a group with over 50 folders registered.
- You can register up to 10 groups.
- The maximum number of destinations registerable to a group is 500.

Note

- You can set a protection code to prevent unauthorized access to the folders registered in a group. For details, see "Registering a Protection Code".

Reference

p.3 "Accessing User Tools (System Settings)"

p.209 "Registering a Protection Code"

Registering a Group

- 1** Press [System Settings].

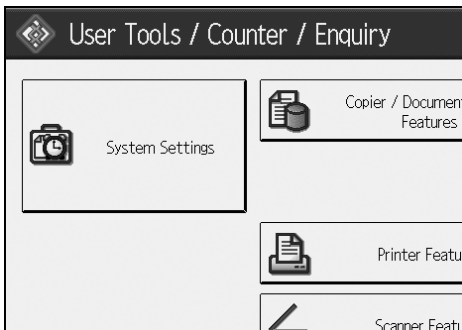

- 2** Press [Administrator Tools].
- 3** Press [Address Book: Program / Change / Delete Group].
- 4** Check that [Program / Change] is selected.
- 5** Press [New Program].

6 Press **[Change]** under **Group Name**.

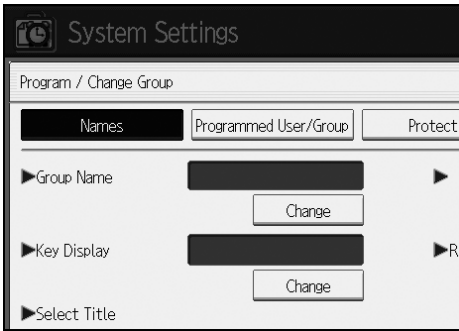

7 Enter the group name, and then press **[OK]**.

The Key Display name is set automatically.

8 Press the title key under **Select Title**, if necessary.

9 When you want to change the key display, press **[Change]** under **Key Display**. Enter the key display, and then press **[OK]**.

10 Press **[OK]**.

Note

- The keys you can select are as follows:
 - **[Frequent]**: Added to the page that is displayed first.
 - **[AB], [CD], [EF], [GH], [IJK], [LMN], [OPQ], [RST], [UVW], [XYZ], [1] to [10]**...
Added to the list of items in the selected title.
- You can select **[Frequent]** and one more page for each title.

Reference

"Entering Text", About This Machine

Registering Names to a Group

You can put names that have been registered in the Address Book into a group. When registering new names, you can also register groups at the same time.

- 1 Press [System Settings].

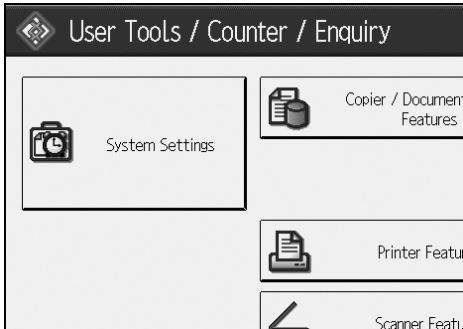

- 2 Press [Administrator Tools].
- 3 Press [Address Book Management].
- 4 Check that [Program / Change] is selected.
- 5 Select the name to register in a group.

Press the name key, or enter the registered number using the number keys.

You can search by the registered name, user code, folder name, or e-mail address.

- 6 Press [Add to Group].

7 Select a group to which you want to add the name to.

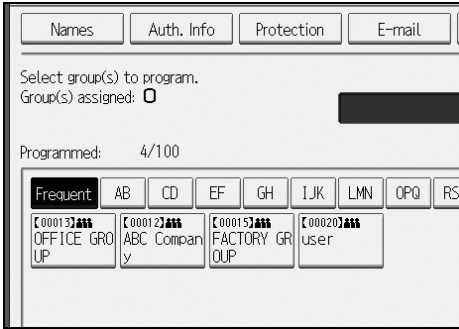

The group key that you have selected becomes highlighted, and the name is added to it.

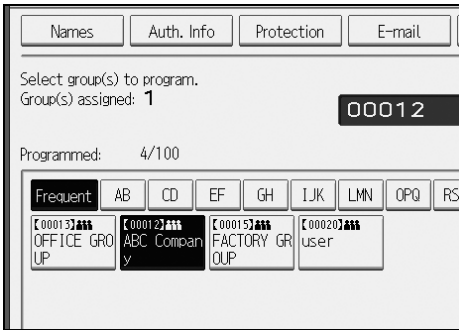

8 Press [OK].

Adding a Groupe to Another Group

You can add a group to another group.

1 Press [System Settings].

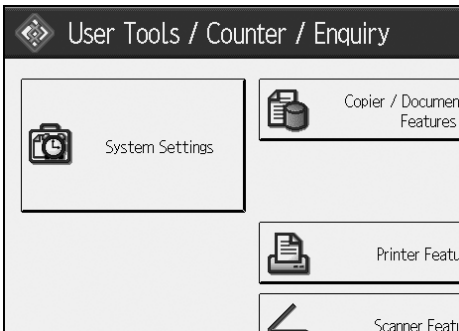

2 Press [Administrator Tools].

3 Press [Address Book: Program / Change / Delete Group].

4 Check that [Program / Change] is selected.

5 Select the group that you want to put into another group.

Press the group key, or enter the registered number using the number keys.

You can search by the registered name, user code, folder name, or e-mail address.

6 Press [Add to Group].

7 Select the group which you want to add to.

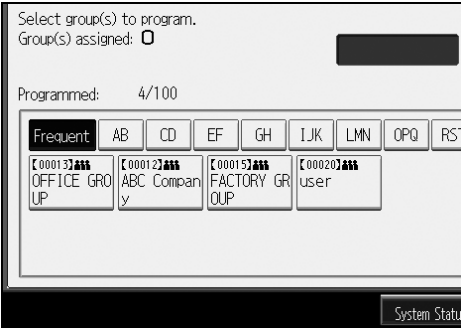

The group key that you have selected becomes highlighted, and the group is added to it.

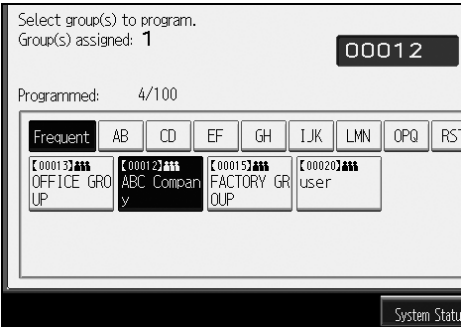

6

8 Press [OK].

Displaying Names Registered in a Group

You can check the names or groups registered in each group.

1 Press [System Settings].

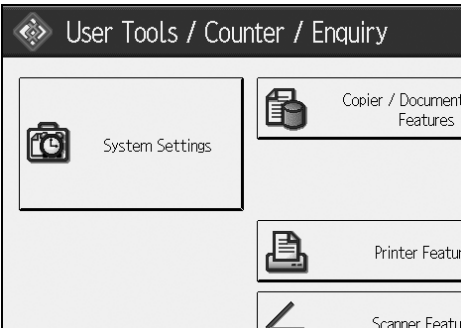

2 Press [Administrator Tools].

3 Press [Address Book: Program / Change / Delete Group].

4 Check that [Program / Change] is selected.

5 Select the group where the members you want to check is egistered.

You can search by the registered name, user code, folder name, or e-mail address.

6 Press [Programmed User/Group].

All the names registered will be displayed.

7 Press [OK].

Removing a Name from a Group

1 Press [System Settings].

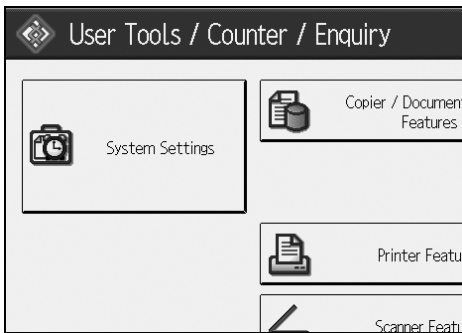

2 Press [Administrator Tools].

3 Press [Address Book Management].

4 Check that [Program / Change] is selected.

5 Select the name to remove from a group.

Press the name key, or enter the registered number using the number keys.

You can search by the registered name, user code, folder name, or e-mail address.

6 Press [Add to Group].

7 Select the group from which you want to remove the name.

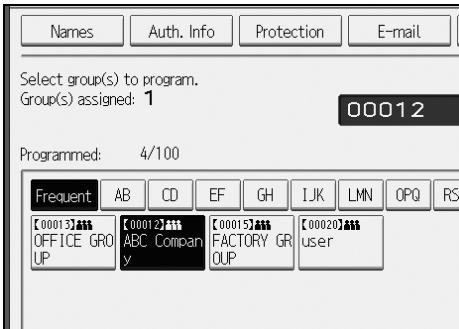

The group key is deselected, and the name is removed from it.

8 Press [OK].

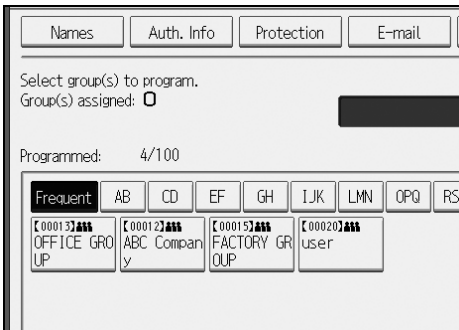

Deleting a Group Within Another Group

1 Press [System Settings].

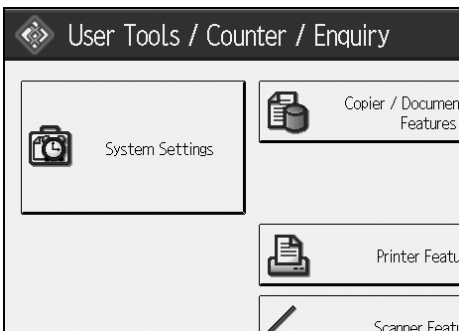

2 Press [Administrator Tools].

3 Press [Address Book: Program / Change / Delete Group].

4 Check that [Program / Change] is selected.

5 Select the group that you want to delete from.

Press the group key, or enter the registered number during the number keys. You can search by the registered name, user code, folder name, or e-mail address.

6 Press [Add to Group].

The keys of groups in which the group is registered appear highlighted.

7 Select the group that you want to delete from.

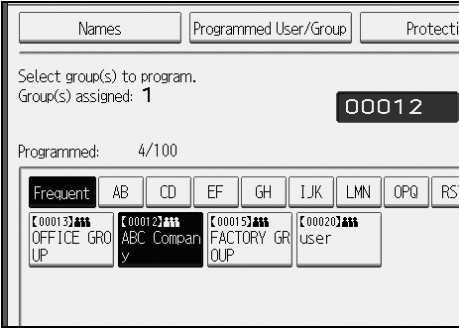

The group key is deselected and the group is deleted from it.

6

8 [OK].

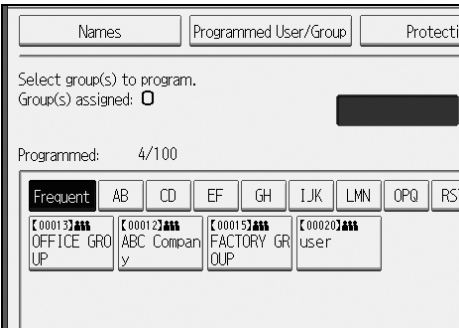

Changing a Group Name

- 1 Press [System Settings].

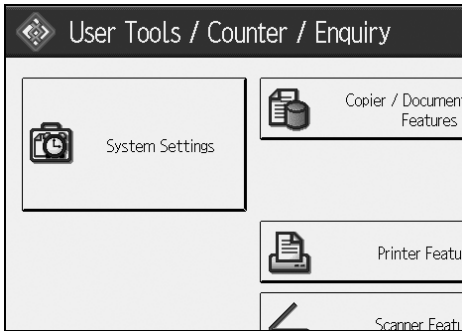

- 2 Press [Administrator Tools].
- 3 Press [Address Book: Program / Change / Delete Group].

- 4 Check that [Program / Change] is selected.

- 5 Press the group key you want to change.

You can search by the registered name, user code, folder name, or e-mail address.

- 6 To change the group name and key display, press [Change] under Group Name or Key Display.

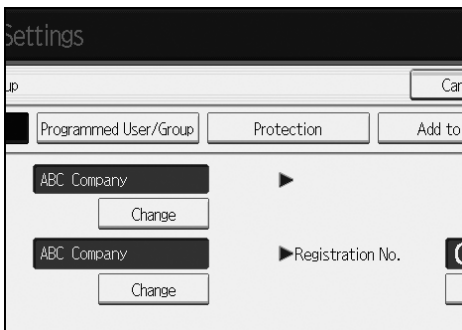

- 7 Enter the new group name or key display, and then press [OK].
- 8 To change the title, press the title key under Select Title.
- 9 To change the registration number, press [Change] under Registration No..
- 10 Enter the new registration number using the number keys.
- 11 Press the [#] key.
- 12 Press [OK].

Deleting a Group

- 1** Press [System Settings].

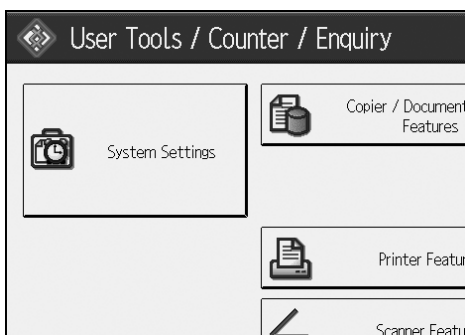

- 2** Press [Administrator Tools].
- 3** Press [Address Book: Program / Change / Delete Group].
- 4** Press [Delete].
- 5** Press [Yes].
- 6** Press a group key you want to delete.

You can search by the registered name, user code, folder name, or e-mail address.

- 7** Press [Yes].

Registering a Protection Code

You can stop sender's names or folders being accessed by setting a protection code.

You can use this function to protect the following:

- Folders
You can prevent unauthorized access to folders.
- Sender's names
You can prevent misuse of sender's names.

Reference

p.3 "Accessing User Tools (System Settings)"

p.168 "Registering a User Code"

Registering a Protection Code to a Single User

1 Press [System Settings].

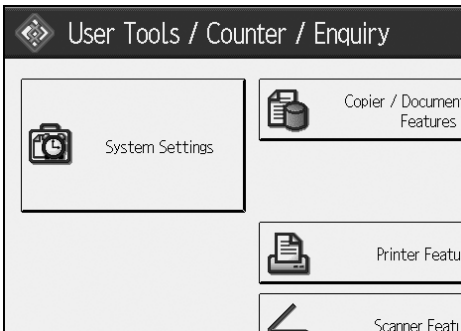

2 Press [Administrator Tools].

3 Press [Address Book Management].

4 Check that [Program / Change] is selected.

5 Select the name whose protection code you want to register.

You can search by the registered name, user code, folder name, or e-mail address.

6 Press **[Protection]**.

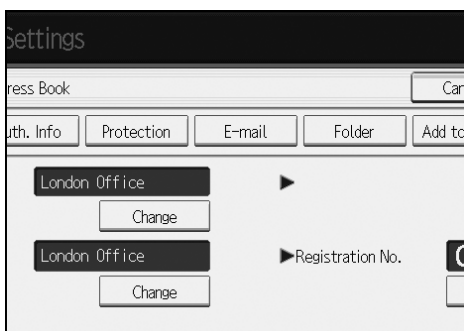

7 Press **[Destination]** or **[Sender]** under Use Name as.

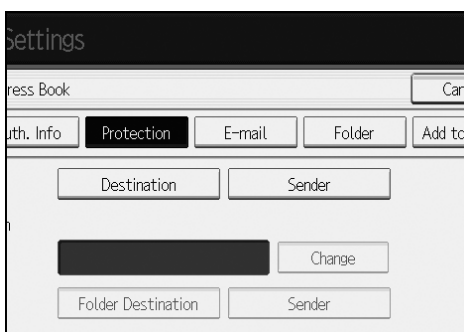

Both **[Destination]** and **[Sender]** can be selected at the same time.

8 Press **[Change]** under Protection Code.

9 Enter a protection code using the number keys, and then press **[#]**.

10 Press **[OK]**.

11 Press **[Exit]**.

 **Note**

- You can specify a protection code of up to eight digits. You can also specify "Protection" without specifying a protection code.

Registering a Protection Code to a Group User

- 1 Press [System Settings].

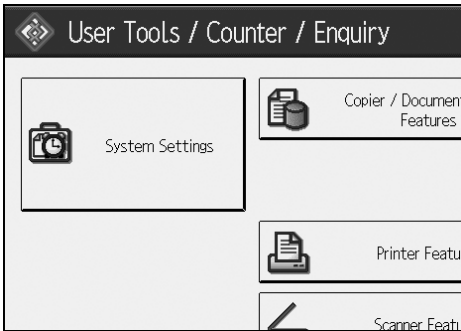

- 2 Press [Administrator Tools].
- 3 Press [Address Book: Program / Change / Delete Group].
- 4 Check that [Program / Change] is selected.
- 5 Press the group key you want to register or enter the registered number using the number keys.
- 6 Press [Protection].
- 7 Press [Folder Destination] under Protection Object.
- 8 Press [Change] under Protection Code.
- 9 Enter a protection code using the number keys, and then press the [#] key.
- 10 Press [OK].
- 11 Press [Exit].

 **Note**

- You can specify a protection code of up to eight digits. You can also specify "Protection" without specifying a protection code.

Registering SMTP and LDAP Authentication

Reference

p.3 “Accessing User Tools (System Settings)”

SMTP Authentication

For each user registered in the Address Book, you can register a login user name and login password to be used when accessing an SMTP server.

To use an SMTP server, you need to program it beforehand.

Important

- When [Do not Specify] is selected for SMTP Authentication, the User Name and Password that you have specified in SMTP Authentication of File Transfer settings applies. For details, see "File Transfer".
- If user authentication is running, consult the administrator.

1 Press [System Settings].

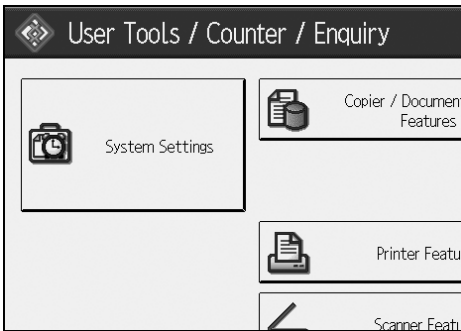

2 Press [Administrator Tools].

3 Press [Address Book Management].

4 Check that [Program / Change] is selected.

5 Press the name you want to register or enter the registered number using the number keys

You can search by the registered name, user code, folder name, or e-mail address.

6 Press [Auth. Info].

7 Press [Specify Other Auth. Info] on the right side of SMTP Authentication.

8 Press [Change] under Login User Name.

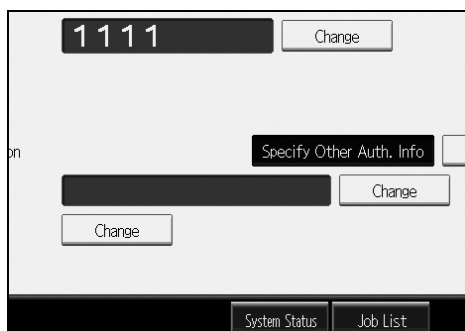

9 Enter the login user name, and then press [OK].

10 Press [Change] under Login Password.

11 Enter the password, and then press [OK].

12 Enter the password again to confirm, and then press [OK].

13 [OK].

Note

- To register the name, see “Registering Names”.
- You can enter up to 191 characters for the user name.
- When using POP before SMTP Authentication, you can enter up to 63 alphanumeric characters.
- You can enter up to 64 characters for the password.
- To change the SMTP Authentication settings, repeat step **2** to **13**.

Reference

- p.163 “Registering Names”
- p.14 “Network Settings”
- “Entering Text”, About This Machine

LDAP Authentication

For each user registered in the Address Book, you can register a login user name and login password to be used when accessing an LDAP server.

To use an LDAP server, you need to program it beforehand. For details, see "LDAP Server Settings", Network Guide.

Important

- When **[Do not Specify]** is selected for LDAP Authentication, the User Name and Password that you have specified in Program / Change LDAP Server of Administrator Tools settings applies. For details, see "LDAP Server Settings".
- If there is user authentication in place, check with the administrator.

1 Press [System Settings].



2 Press [Administrator Tools].

3 Press [Address Book Management].

4 Check that [Program / Change] is selected.

You can search by the registered name, user code, folder name, or e-mail address.

5 Press the name you want to register or enter the registered number using the number keys.

6 Press [Auth. Info], and then press [Next].

7 Press [Specify Other Auth. Info] on the right side of LDAP Authentication.

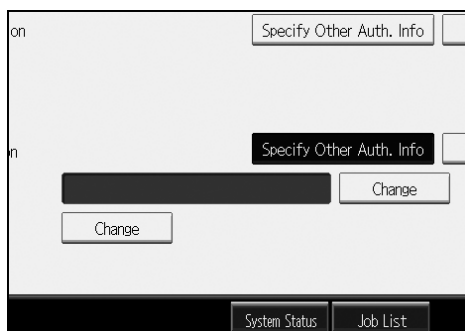
8 Press [Change] under Login User Name.**9** Enter the login user name, and then press [OK].**10** Press [Change] under Login Password.**11** Enter the password, and then press [OK].**12** Enter the password again to confirm, and then press [OK].**13** Press [OK].**Note**

- To register the name, see “Registering Names”.
- When [**Do not Specify**] is selected for LDAP Authentication, the User Name and Password that you have specified in Program / Change LDAP Server of Administrator Tools settings applies.
- You can enter up to 128 characters for the user name.
- To change the LDAP Authentication settings, repeat step **2** to **13**.

Reference

p.163 “Registering Names”
 "Entering Text", About This Machine

7. Other User Tools

Initial settings allow you switch the language as well as checking the number of printed papers by displaying the counter.

Changing the Display Language

You can change the language used on the display. English is set as default.

1 Press [Français].

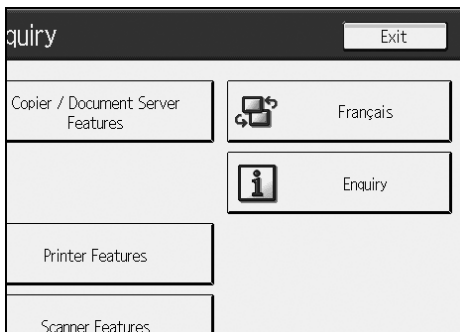

The language is changed to French.

2 Press [Sortie].

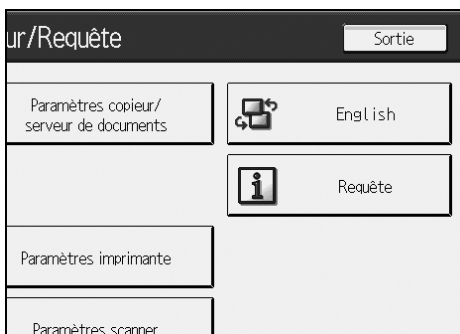

The menu appears in French.

Reference

p.3 "Accessing User Tools (System Settings)"

Enquiry

The enquiry function lets you check the telephone numbers to contact for repairs, or ordering consumables such as toner. Be sure to contact your service engineer to verify the following:

❖ Consumables

- Telephone No. to order
- Toner
- Staple
- Staple (Centre)

❖ Machine Maintenance/Repair

- Telephone No.
- Serial No. of Machine

❖ Sales Representative

- Telephone No.

1 Press [Enquiry].

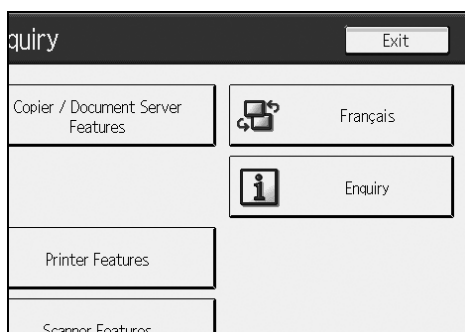

Enquiry information appears.

2 Press [Print Enquiry List].

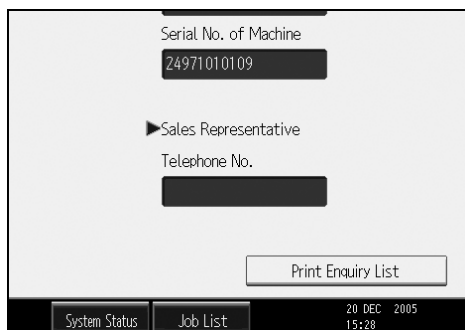

3 Press the **[Start]** key.
Enquiry information prints out.

4 Press **[Exit]** twice.



Reference

p.3 “Accessing User Tools (System Settings)”

Counter

Displaying the Total Counter

You can display the total counter value used for all functions.

You can also print out a counter data list.

1 Press **[Counter]**.

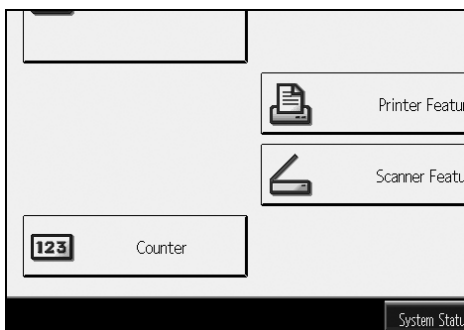

2 To print a counter list, press **[Print Counter List]**.

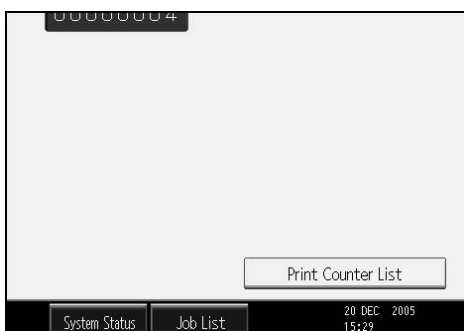

3 Press the **[Start]** key.

A counter list prints out.

4 Press **[Exit]** twice.





















 **Reference**

p.3 “Accessing User Tools (System Settings)”

Specifications for the Main Unit

- ❖ **Configuration:**
Console
- ❖ **Photosensitivity type:**
OPC drum
- ❖ **Original scanning:**
CCD-CIS
- ❖ **Copy process:**
Dry electrostatic transfer system
- ❖ **Development:**
Dry two-component magnetic brush development system
- ❖ **Fusing:**
Heating roll pressure system
- ❖ **Resolution:**
 - Scanning original: 600dpi
 - Printing: 1200 dpi
- ❖ **Exposure glass:**
Stationary original exposure type
- ❖ **Original reference position:**
Rear left corner
- ❖ **Warm-up time:**
30 seconds or less (20°C, 68°F)
- ❖ **Originals:**
Sheet/book/objects
- ❖ **Maximum original size:**
A3☐, 11" × 17"☐, Long length: 1260 mm
- ❖ **Minimum original size:**
B6 JIS, 5¹/₂" × 8¹/₂" (when using the ADF)

❖ **Copy paper size:**

- Trays: A3  – A5  , 11" × 17"  – 5¹/₂" × 8¹/₂"  , 8K (267 × 390 mm) , 16K (195 × 267 mm)  
- Bypass Tray: A3 , 11" × 17"  – A6 
- Bypass (custom size):
Vertical: 100 – 305 mm, 4" – 12"
Horizontal: 139.7 – 600 mm, 5.5" – 23.6"
- Duplex: A3  – A5  , 11" × 17"  – 5¹/₂" × 8¹/₂"  , 8K , 16K  



❖ **Copy paper weight:**

- Paper tray: 52.3 – 127.9 g/m², 14 – 34 lb.
- Bypass tray: 52.3 – 157 g/m², 14 – 42 lb.
52.3 – 216 g/m², 14 – 57.6 lb. (Thick Paper mode)
- Duplex: 64 – 127.9 g/m², 17 – 34 lb.



❖ **Non-reproduction area:**

- Leading edge: 4 ± 2 mm
- Trailing edge: 2 ± 2 mm
- Left edge: 2 ± 1.5 mm
- Right edge: 0.5 mm





❖ **First copy time: (Type 1)**

- 4.2 seconds or less
(A4 , 8¹/₂" × 11" , 100% reproduction, feeding from tray 1, on the exposure glass)





❖ **First copy time: (Type 2, 3)**

- 3.5 seconds or less
(A4 , 8¹/₂" × 11" , 100% reproduction, feeding from tray 1, on the exposure glass)





❖ **Copying speed: (Type 1)**

- 31 copies/minute (A3 , 11" × 17" )
- 55 copies/minute (A4 , 8¹/₂" × 11" )

❖ **Copying speed: (Type 2)**

- 36 copies/minute (A3 , 11" × 17" )
- 65 copies/minute (A4 , 8¹/₂" × 11" )

❖ **Copying speed: (Type 3)**

- 38 copies/minute (A3 , 11" × 17" )
- 75 copies/minute (A4 , 8¹/₂" × 11" )

❖ **Reproduction ratio:**

- Metric version:
 - Enlargement: 400%, 200%, 141%, 122%, 115%
 - Full Size: 100%
 - Reduction: 93%, 82%, 75%, 71%, 65%, 50%, 25%
- Inch version:
 - Enlargement: 400%, 200%, 155%, 129%, 121%
 - Full Size: 100%
 - Reduction: 93%, 85%, 78%, 73%, 65%, 50%, 25%

Zoom: From 25 to 400% in 1% steps.

❖ **Maximum continuous copy run:**

999 sets

❖ **Copy paper capacity:**

- Tray 1 (Tandem tray) : 3,100 sheets (1,550 sheets × 2) (80 g/m², 20 lb.)
- Tray 2 – 3 (550-sheet tray) : 550 sheets (80 g/m², 20 lb.)
- Bypass tray: 100 sheets (69 g/m², 18 lb.)

❖ **Power consumption:**

Mainframe only:

	Type 1	Type 2	Type 3
Warm-up	about 1.77 kW	about 1.78 kW	about 1.78 kW
Stand-by	about 0.299 kW	about 0.299 kW	about 0.299 kW
During printing	about 1.4 kW	about 1.41 kW	about 1.41 kW
Maximum	about 1.77 kW	about 1.78 kW	about 1.78 kW

Complete system: ^{*1}

	Type 1	Type 2	Type 3
Warm-up	about 1.81 kW	about 1.82 kW	about 1.83 kW
Stand-by	about 0.346 kW	about 0.346 kW	about 0.346 kW
During printing	about 1.53 kW	about 1.56 kW	about 1.56 kW
Maximum	about 1.81 kW	about 1.82 kW	about 1.83 kW

^{*1} The Complete system consists of the mainframe, finisher, large capacity tray (LCT) and interposer.

❖ **Dimensions (W × D × H up to exposure glass):**

690 × 790 × 985(1165 ^{*1}) mm, 27.2" × 31.1" × 38.8"(45.9" ^{*1})

^{*1} When the ADF is included

❖ **Space for mainframe (W × D):**

1,175 × 790 mm, 46.3" × 31.1"

❖ **Noise emission:** *1

Sound Power Level (Mainframe only):

	Type 1	Type 2	Type 3
Stand-by	less than 35 dB(A)	less than 35 dB(A)	less than 35 dB(A)
Copying	less than 68 dB(A)	less than 69 dB(A)	less than 69 dB(A)

Sound Power Level (Complete system *3):

	Type 1	Type 2	Type 3
Stand-by	less than 36 dB(A)	less than 36 dB(A)	less than 36 dB(A)
Copying	less than 74 dB(A)	less than 75 dB(A)	less than 75 dB(A)

Sound Pressure Level *2 (Mainframe only):

	Type 1	Type 2	Type 3
Stand-by	less than 21 dB(A)	less than 21 dB(A)	less than 21 dB(A)
Copying	less than 53 dB(A)	less than 55 dB(A)	less than 54 dB(A)

Sound Pressure Level *2 (Complete system *3):

	Type 1	Type 2	Type 3
Stand-by	less than 19 dB(A)	less than 19 dB(A)	less than 19 dB(A)
Copying	less than 63 dB(A)	less than 63 dB(A)	less than 63 dB(A)

*1 The above measurements made in accordance with ISO 7779 are actual value.

*2 It is measured at the position of the bystander.

*3 The Complete system consists of the mainframe, finisher, large capacity tray (LCT) and interposer.

❖ **Weight:**

Approx. 206 kg, 454 lb

Document Server

- ❖ **HDD:**
80 GB
- ❖ **HDD (Document Server):**
36.4 GB
- ❖ **Capacity:**
 - Copy: Approx. 2,000 pages (ITUT-No.4 chart)
 - Batch mode: Approx. 2,000 pages (ITUT-No.4 chart)
 - Printer: Approx. 1,000 pages (600 dpi)
 - Scanner: Approx. 2,000 pages (200 dpi/Text) (ITUT-No.4 chart) *¹
- ❖ **Maximum number of stored documents:**
3,000 documents
- ❖ **Maximum pages of stored documents:**
10,000 pages
- ❖ **Maximum number of pages per document:**
2,000 pages
- ❖ **Capacity (Memory Sorting):**
5 GB (A4/8¹/₂" × 11" : Approx. 2,000 sheets at maximum) *²
- ❖ **Capacity (Others):**
7.2 GB

*¹ Scanning Conditions: ITUT-No. 4 chart/200 dpi/Text/A4/MMR

*² The capacity differs depending on the functions are used.







Auto Document Feeder

❖ Mode:







Batch (SADF) mode, Mixed Sizes mode, Paper Orientation mode

❖ Original size:

Metric version:

- A3  - B6 JIS   (1-sided originals)
- A3  - A5   (2-sided originals)

Inch version:

- 11" × 17"  - 5¹/₂" × 8¹/₂"   (1-sided originals)
- 11" × 17"  - 5¹/₂" × 8¹/₂"   (2-sided originals)

❖ Original weight:

- 1-sided originals: 40 - 127.9 g/m² (11 - 34 lb.)
- 2-sided originals: 52 - 127.9 g/m² (14 - 34 lb.)

❖ Number of originals to be set:

100 sheets (81.4 g/m², 22 lb.) or less than 12 mm, 0.4"

❖ Maximum power consumption:

Less than 110W (power is supplied from the main unit)

❖ Dimensions (W×D×H)

680 × 560 × 180 mm, 26.8" × 22" × 7.1"

❖ Weight:

Approx. 18 kg, 39.7 lb.

 **Note**

- Specifications are subject to change without notice.

Specifications for Options

Note

- Specifications are subject to change without notice.

Mailbox

❖ Number of trays:

9 trays

❖ Paper size:

A3, B4 JIS, A4, B5 JIS, A5^{*1}, 11" × 17", 8¹/₂" × 14", 8¹/₂" × 11", 5¹/₂" × 8¹/₂"^{*1}

^{*1} These sizes cannot be detected automatically.

❖ Paper capacity:

100 sheets (80 g/m², 20 lb.) per tray

❖ Paper weight:

52 – 127.9 g/m², 14 – 34 lb.

❖ Power consumption:

Approx. 48W (power is supplied from the main unit)

❖ Dimensions (W × D × H):

540 × 600 × 660 mm, 21.3" × 23.6" × 26"

❖ Weight:

Approx. 15 kg, 33 lb.

Booklet Finisher

Finisher Upper Tray:

❖ Paper size:

Without Z-fold:

A3, B4 JIS, A4, B5 JIS, A5, B6 JIS, A6, 11" × 17",
11" × 14", 10" × 15", 10" × 14", 8½" × 14", 8½" × 13", 8½" × 11",
8¼" × 14", 8¼" × 13", 8" × 13", 8" × 10½", 8" × 10",
5½" × 8½", 7¼" × 10½", 12" × 18"

With Z-fold:

A3, B4 JIS, A4, 11" × 17", 8½" × 14", 8½" × 11"

❖ Paper weight:

Without Z-fold:

52 – 163 g/m², 14 – 43 lb.

With Z-fold:

64 – 80 g/m², 17 – 21 lb.

❖ Stack capacity:

Without Z-fold:

- 250 sheets (A4, B5 JIS, A5, B6 JIS, A6, 8½" × 11", 5½" × 8½") (80 g/m², 20 lb.)
- 50 sheets (A3, B4 JIS, 8½" × 14") (80 g/m², 20 lb.)

With Z-fold:

- 30 sheets (A3, B4 JIS) (80 g/m², 20 lb.)
- 20 sheets (A4, B5 JIS, A5, B6 JIS, A6, 8½" × 11", 5½" × 8½") (80 g/m², 20 lb.)

Finisher Shift Tray:

❖ Paper size:

Without Z-fold:

A3, B4 JIS, A4, B5 JIS, A5, B6 JIS, A6, 11" × 17",
11" × 14", 10" × 15", 10" × 14", 8½" × 14", 8½" × 13", 8½" × 11",
8¼" × 14", 8¼" × 13", 8" × 13", 8" × 10½", 8" × 10",
5½" × 8½", 7¼" × 10½", 12" × 18"

With Z-fold:

A3, B4 JIS, A4, 11" × 17", 8½" × 14", 8½" × 11"

❖ Paper weight:

Without Z-fold:

















52 – 256 g/m², 14 – 68 lb.

With Z-fold:







64 – 80 g/m², 17 – 21 lb.

❖ **Stack capacity:**

Without Z-fold:







- 2,000 sheets (A4 , , 8 1/2"×11" , ) (80 g/m², 20 lb.)
- 1,000 sheets (A3 , B4 JIS , A4 , B5 JIS , 11"×17" , 8 1/2"×14" , 8 1/2"×11" , 12"×18" ) (80 g/m², 20 lb.)
- 500 sheets (A5 ) (80 g/m², 20 lb.)
- 100 sheets (A5 , B6 JIS , A6 , 5 1/2"×8 1/2" ) (80 g/m², 20 lb.)

With Z-fold:

- 30 sheets (A3, B4 JIS) (80 g/m², 20 lb.)
- 20 sheets (A4 , B5 JIS , A5 , B6 JIS , A6 , 8 1/2" × 11" , 5 1/2" × 8 1/2" ) (80 g/m², 20 lb.)

❖ **Staple paper size:**

Without Z-fold:

A3 , B4 JIS , A4 , B5 JIS , 11" × 17" , 8 1/2" × 14" , 8 1/2" × 11" 

With Z-fold:

A3 , B4 JIS , 11" × 17" ❖ **Staple paper weight:**







Without Z-fold:

64 – 90 g/m², 17 – 28 lb.







With Z-fold:

64 – 80 g/m², 17 – 21.3 lb.❖ **Staple capacity:**



Without Mixed Size:

- 50 sheets (A4 , B5 JIS , 8 1/2" × 11" ) (80 g/m², 20 lb.)
- 30 sheets (A3 , B4 JIS , 11" × 17" , 8 1/2" × 14" ) (80 g/m², 20 lb.)

With Mixed Size:











- 30 sheets (A3 , B4 JIS , A4 , B5 JIS , 11" × 17" , 8 1/2" × 11" ) (80 g/m², 20 lb.)

With Z-fold:







- 5 sheets (A3 , B4 JIS , 11"×17" ) (80 g/m², 20 lb.)

❖ **Stack capacity after stapling**

Without Mixed Size:

- 150-40 sets (13-50 sheets) (A4 , 8 1/2"×11" ) (80 g/m², 20 lb.)
- 150 sets (2-12 sheets) (A4 , 8 1/2"×11" ) (80 g/m², 20 lb.)
- 100-20 sets (10-50 sheets) (A4 , B5 , 8 1/2"×11" ) (80 g/m², 20 lb.)
- 100 sets (2-9 sheets) (A4 , B5 , 8 1/2"×11" ) (80 g/m², 20 lb.)
- 100-33 sets (10-30 sheets) (other paper size) (80 g/m², 20 lb.)
- 100 sets (2-9 sheets) (other paper size) (80 g/m², 20 lb.)

With Mixed Size:

- 50 sets (2–30 sheets)
(A3  / A4 , B4 JIS  / B5 JIS , 11"×17"  / 8 1/2"×11" ) (80 g/m², 20 lb.)

❖ **Staple position:**

4 position (Top, Top Slant, Bottom, 2 Staples)

Booklet Tray:

❖ **Saddle stitch paper size:**

A3☐, B4 JIS☐, A4☐, B5 JIS☐, 11"×17"☐, 8¹/₂"×14"☐, 8¹/₂"×11"☐, 12"×18"☐

❖ **Saddle stitch paper weight:**

64 – 90 g/m², 17 – 28 lb.

❖ **Saddle stitch capacity:**

1 set (15 sheets)

❖ **Stack capacity after Saddle stitching**

- 30 sets (2-5 sheets) (A3☐, B4 JIS☐, A4☐, B5 JIS☐, 11"×17"☐, 8¹/₂"×14"☐, 8¹/₂"×11"☐, 12"×18"☐) (80 g/m², 20 lb.)
- 15 sets (6-10 sheets) (A3☐, B4 JIS☐, A4☐, B5 JIS☐, 11"×17"☐, 8¹/₂"×14"☐, 8¹/₂"×11"☐, 12"×18"☐) (80 g/m², 20 lb.)
- 10 sets (11-15 sheets) (A3☐, B4 JIS☐, A4☐, B5 JIS☐, 11"×17"☐, 8¹/₂"×14"☐, 8¹/₂"×11"☐, 12"×18"☐) (80 g/m², 20 lb.)

❖ **Saddle stitch position:**

Centre 2 position

❖ **Power consumption:**

Approx. 96W (power supplied from main unit)

❖ **Dimensions (W × D × H):**

657 × 613 × 960 mm, 25.8" × 24.2" × 37.8"

❖ **Weight:**

Approx. 63 kg, 138.9 lb.

3,000Sheet-50Sheet Staple Finisher

Finisher Upper Tray:

❖ Paper size:

A3, B4 JIS, A4, B5 JIS, A5, B6 JIS, A6, 11" × 17",
11" × 14", 10" × 15", 10" × 14", 8½" × 14", 8½" × 13", 8½" × 11",
8¼" × 14", 8¼" × 13", 8" × 13", 8" × 10½", 8" × 10",
5½" × 8½", 7¼" × 10½", 12" × 18"

❖ Paper weight:

52 – 163 g/m², 14 – 43 lb.

❖ Stack capacity:

- 250 sheets (A4, B5 JIS, A5, B6 JIS, A6, 8½" × 11", 5½" × 8½") (80 g/m², 20 lb.)
- 50 sheets (A3, B4 JIS, 8½" × 14") (80 g/m², 20 lb.)

Finisher Shift Tray:

❖ Paper size:

A3, B4 JIS, A4, B5 JIS, A5, B6 JIS, A6, 11" × 17",
11" × 14", 10" × 15", 10" × 14", 8½" × 14", 8½" × 13", 8½" × 11",
8¼" × 14", 8¼" × 13", 8" × 13", 8" × 10½", 8" × 10",
5½" × 8½", 7¼" × 10½", 12" × 18"

❖ Paper weight:

52 – 256 g/m², 14 – 68 lb.

❖ Stack capacity:

- 3,000 sheets (A4, 8½" × 11") (80 g/m², 20 lb.)
- 1,500 sheets (A3, B4 JIS, A4, B5 JIS, 11" × 17", 8½" × 14", 8½" × 11", 12" × 18") (80 g/m², 20 lb.)
- 100 sheets (A5, B6 JIS, A6, 5½" × 8½") (80 g/m², 20 lb.)

❖ Staple paper size:







A3, B4 JIS, A4, B5 JIS, 11" × 17", 8½" × 14", 8½" × 11"

❖ Staple paper weight:







64 – 157 g/m², 17 – 42 lb.

❖ **Staple capacity:**

Without Mixed Size:











- 50 sheets (A4 , B5 JIS , 8¹/₂" × 11" ) (80 g/m², 20 lb.)
- 30 sheets (A3 , B4 JIS , 11" × 17" , 8¹/₂" × 14" ) (80 g/m², 20 lb.)

With Mixed Size:







- 30 sheets (A3 , A4 , B4 JIS , B5 JIS , 11"×17"  / 8¹/₂"×11" ) (80 g/m², 20 lb.)

❖ **Stack capacity after stapling**

Without Mixed Size mode:

- 150-60 sets (20-50 sheets) (A4 , 8¹/₂"×11" ) (80 g/m², 20 lb.)
- 150 sets (2-19 sheets) (A4 , 8¹/₂"×11" ) (80 g/m², 20 lb.)
- 100-30 sets (15-50 sheets) (A4 , B5 , 8¹/₂"×11" ) (80 g/m², 20 lb.)
- 100 sets (2-14 sheets) (A4 , B5 , 8¹/₂"×11" ) (80 g/m², 20 lb.)
- 100-33 sets (15-30 sheets) (other size paper) (80 g/m², 20 lb.)
- 100 sets (2-14 sheets) (other size paper) (80 g/m², 20 lb.)

With Mixed Size mode:

- 50 sets (2-30 sheets)
(A4 , A3 , B5 JIS , B4 JIS , 8¹/₂" × 11"  / 11" × 17" ) (80 g/m², 20 lb.)

❖ **Staple position:**

4 position (Top, Top Slant, Bottom, 2 Staples)

❖ **Power consumption:**

Approx. 96W (power supplied from main unit)

❖ **Dimensions (W × D × H):**

657 × 613 × 960 mm, 25.8" × 24.2" × 37.8"

❖ **Weight:**

Approx. 54 kg, 119.1 lb.

3,000Sheet-100Sheet Staple Finisher

Finisher Upper Tray:

❖ Paper size:

Without Z-fold:

A3, B4 JIS, A4, B5 JIS, A5, B6 JIS, 11" × 17", 11" × 14",
10" × 15", 10" × 14", 8¹/₂" × 14", 8¹/₂" × 13", 8¹/₂" × 11",
8¹/₄" × 14", 8¹/₄" × 13", 8" × 13", 8" × 10¹/₂", 8" × 10",
5¹/₂" × 8¹/₂", 7¹/₄" × 10¹/₂", 12" × 18"

With Z-fold:

A3, B4 JIS, A4, 11" × 17", 8¹/₂" × 14", 8¹/₂" × 11"

❖ Paper weight:

Without Z-fold:

52 – 216 g/m², 14 – 58 lb.

With Z-fold:

64 – 80 g/m², 17 – 21 lb.

❖ Stack capacity:

Without Z-fold:

- 500 sheets (A4, B5 JIS, A5, B6 JIS, A6, 8¹/₂" × 11", 5¹/₂" × 8¹/₂) (80 g/m², 20 lb.)
- 250 sheets (A3, B4 JIS, 11" × 17", 8¹/₂" × 14", 12" × 18") (80 g/m², 20 lb.)

With Z-fold:

- 30 sheets (A3, B4 JIS) (80 g/m², 20 lb.)
- 20 sheets (A4, B5 JIS, A5, B6 JIS, A6, 8¹/₂" × 11", 5¹/₂" × 8¹/₂) (80 g/m², 20 lb.)

Finisher Shift Tray:

❖ Paper size:

Without Z-fold:

A3, B4 JIS, A4, B5 JIS, A5, B6 JIS, 11" × 17", 11" × 14",
10" × 15", 10" × 14", 8¹/₂" × 14", 8¹/₂" × 13", 8¹/₂" × 11",
8¹/₄" × 14", 8¹/₄" × 13", 8" × 13", 8" × 10¹/₂", 8" × 10",
5¹/₂" × 8¹/₂", 7¹/₄" × 10¹/₂", 12" × 18"

With Z-fold:

A3, B4 JIS, A4, 11" × 17", 8¹/₂" × 14", 8¹/₂" × 11"

❖ Paper weight:

Without Z-fold:















52 – 216 g/m², 14 – 58 lb.

With Z-fold:







64 – 80 g/m², 17 – 21 lb.

❖ **Stack capacity:**

Without Z-fold:











- 3,000 sheets (A4 , B5 JIS , 8¹/₂" × 11" ) (80 g/m², 20 lb.)
- 1,500 sheets (A3 , B4 JIS , A4 , B5 JIS , 11" × 17" , 8¹/₂" × 14" , 8¹/₂" × 11" , 12" × 18" ) (80 g/m², 20 lb.)
- 500 sheets (A5 , 5¹/₂" × 8¹/₂" ) (80 g/m², 20 lb.)
- 100 sheets (A5 , 5¹/₂" × 8¹/₂" ) (80 g/m², 20 lb.)

With Z-fold:

- 30 sheets (A3, B4 JIS) (80 g/m², 20 lb.)
- 20 sheets (A4 , B5 JIS , A5 , B6 JIS , A6 , 8¹/₂" × 11" , 5¹/₂" × 8¹/₂" ) (80 g/m², 20 lb.)

❖ **Staple paper size:**

Without Z-fold:

A3 , B4 JIS , A4 , B5 JIS , 11" × 17" , 11" × 14" , 10" × 15" , 10" × 14" , 8¹/₂" × 14" , 8¹/₂" × 13" , 8¹/₂" × 11" 

With Z-fold:

A3 , B4 JIS , 11" × 17" ❖ **Staple paper weight:**







Without Z-fold:

64 – 80 g/m², 17 – 20 lb.



With Z-fold:

64 – 80 g/m², 17 – 20 lb.❖ **Staple capacity:**















Without Z-fold:

- 100 sheets (A4 , B5 JIS , 8¹/₂" × 11" ) (80 g/m², 20 lb.)
- 50 sheets (A3 , B4 JIS , 11" × 17" ) (80 g/m², 20 lb.)

With Z-fold:

- 10 sheets (A3 , B4 JIS , 11" × 17" ) (80 g/m², 20 lb.)

❖ **Stack capacity after stapling**

- 200–30 sets (10–100 sheets) (A4 , B5 JIS , 8¹/₂" × 11" ) (80 g/m², 20 lb.)
- 150 sets (2–9 sheets) (A4 , B5 JIS , 8¹/₂" × 11" ) (80 g/m², 20 lb.)
- 150–30 sets (10–50 sheets) (A3 , B4 JIS , 11" × 17" , 8¹/₂" × 14" ) (80 g/m², 20 lb.)
- 150 sets (2–9 sheets) (A3 , B4 JIS , 11" × 17" , 8¹/₂" × 14" ) (80 g/m², 20 lb.)

❖ **Staple position:**

4 position (Top, Top Slant, Bottom, 2 Staples)

❖ **Power consumption:**

Approx. 100W (power supplied from main unit)

❖ **Dimensions (W × D × H):**

800 × 730 × 980 mm, 31.5" × 28.7" × 38.6"

❖ **Weight:**

Approx. 65 kg, 143.3 lb.

Punch Unit (Booklet Finisher, 3,000Sheet-50Sheet Staple Finisher)

❖ **Paper size:**

Punch unit type	Paper size
2 & 4 holes type: 2 holes	☐: A3, B4, A4, B5, A5, 11" × 17", 8 ¹ / ₂ " × 14", 8 ¹ / ₂ " × 11", 5 ¹ / ₂ " × 8 ¹ / ₂ "
2 & 4 holes type: 2 holes	☐: A4, B5, A5, 8 ¹ / ₂ " × 11", 5 ¹ / ₂ " × 8 ¹ / ₂ "
2 & 4 holes type: 4 holes	☐: A3, B4, 11" × 17"
2 & 4 holes type: 4 holes	☐: A4, B5, 8 ¹ / ₂ " × 11"
4 holes type: 4 holes	☐: A3, B4, A4, B5, A5, 11" × 17", 8 ¹ / ₂ " × 14", 8 ¹ / ₂ " × 11", 5 ¹ / ₂ " × 8 ¹ / ₂ "
4 holes type: 4 holes	☐: A4, B5, A5, 8 ¹ / ₂ " × 11", 5 ¹ / ₂ " × 8 ¹ / ₂ "
2 & 3 holes type: 2 holes	☐: A3, B4, A4, B5, A5, 11" × 17", 8 ¹ / ₂ " × 14", 8 ¹ / ₂ " × 11", 5 ¹ / ₂ " × 8 ¹ / ₂ "
2 & 3 holes type: 2 holes	☐: A4, B5, A5, 8 ¹ / ₂ " × 11", 5 ¹ / ₂ " × 8 ¹ / ₂ "
2 & 3 holes type: 3 holes	☐: A3, B4, 11" × 17"
2 & 3 holes type: 3 holes	☐: A4, B5, 8 ¹ / ₂ " × 11"

❖ **Paper weight:**

52 – 163 g/m², 14 lb. – 43 lb.

❖ **Power consumption:**

20W (power supplied from main unit.)

❖ **Dimensions (W × D × H):**

110 × 484 × 117 mm, 4.3" × 19" × 4.6"

❖ **Weight:**

Approx. 2.5 kg, 5.5 lb

Punch Unit (3,000Sheet-100Sheet Staple Finisher)

❖ Paper size:

Punch unit type	Paper size
2 & 4 holes type: 2 holes	☐: A3, B4 JIS, A4, B5 JIS, A5, B6 JIS, A6, 11" × 17", 8 ¹ / ₂ "×14", 8 ¹ / ₂ "×11", 5 ¹ / ₂ " × 8 ¹ / ₂ "
2 & 4 holes type: 2 holes	☐: A4, B5 JIS, A5, 8 ¹ / ₂ " × 11", 5 ¹ / ₂ " × 8 ¹ / ₂ "
2 & 4 holes type: 4 holes	☐: A3, B4 JIS, 11" × 17"
2 & 4 holes type: 4 holes	☐: A4, B5 JIS, 8 ¹ / ₂ " × 11"
4 holes type: 4 holes	☐: A3, B4 JIS, A4, B5 JIS, A5, B6 JIS, 11"×17", 8 ¹ / ₂ "×14", 8 ¹ / ₂ "×11", 5 ¹ / ₂ "×8 ¹ / ₂ "
4 holes type: 4 holes	☐: A4, B5 JIS, A5, 8 ¹ / ₂ "×11", 8 ¹ / ₂ "×5 ¹ / ₂ "
2 & 3 holes type: 2 holes	☐: A3, B4 JIS, A4, B5 JIS, A5, B6 JIS, A6, 11"×17", 8 ¹ / ₂ "×14", 8 ¹ / ₂ "×11", 5 ¹ / ₂ "×8 ¹ / ₂ "
2 & 3 holes type: 2 holes	☐: A4, B5 JIS, A5, 8 ¹ / ₂ "×11", 5 ¹ / ₂ "×8 ¹ / ₂ "
2 & 3 holes type: 3 holes	☐: A3, B4 JIS, 11"×17"
2 & 3 holes type: 3 holes	☐: A4, B5 JIS, 8 ¹ / ₂ "×11"

❖ Paper weight:

- 4 holes: 52 – 127.9 g/m², 14 lb. – 34 lb.
- 2 & 3 holes: 52 – 163 g/m², 14 lb. – 43 lb.

❖ Power consumption:

60W (power supplied from main unit)

❖ Dimensions (W × D × H):

- 4 holes: 85 × 460 × 100 mm, 3.4" × 18.2" × 3.9"
- 2 & 3 holes, 2 & 4 holes: 105 × 463 × 100 mm, 4.1" × 18.2" × 3.9"

❖ Weight:







- 4 holes: Approx. 3 kg, 6.7 lb
- 2 & 3 holes, 2 & 4 holes: Approx. 4 kg, 8.9 lb

Z-folding unit

Note

To use the Z-folding unit, the 3,000Sheet-100Sheet Staple Finisher is required.

❖ Paper size:

A3 , B4 JIS , A4 , 12" × 18" , 11" × 17" , 8¹/₂" × 14" , 8¹/₂" × 11" 

❖ Paper weight:

Without Z-fold:

52 – 256 g/m², 14 – 68.3 lb.

With Z-fold:

64 – 80 g/m², 17 – 21 lb.

❖ Power consumption:

Maximum. 100W (a separate power source is required)

❖ Dimensions (W × D × H):

177 × 620 × 960 mm, 6.9" × 24.4" × 37.8"

❖ Weight:

Approx. 55 kg, 121.3 lb

Copy tray

❖ Paper capacity:

- A3, 11" × 17" : 250 sheets
- B4 JIS, 8¹/₂" × 14" : 500 sheets
- A4, 8¹/₂" × 11" : 500 sheets
- B5 JIS, 5¹/₂" × 8¹/₂" : 250 sheets

❖ Dimensions (W × D × H):

390 × 330 × 130 mm, 15.4" × 13" × 5.1"

❖ Weight:

Approx. 650 g, 1.4 lb

Large Capacity Tray (LCT)

- ❖ **Paper size:**
A4 ☐, B5 JIS ☐, 8¹/₂" × 11" ☐
- ❖ **Paper weight:**
52 – 127.9 g/m², 14 – 34 lb.
- ❖ **Paper capacity:**
4,000 sheets (80 g/m², 20 lb.)
- ❖ **Power consumption**
Maximum. 50 W (power supplied from main unit)
- ❖ **Dimensions (W × D × H, option unit):**
314 × 458 × 659 mm, 12.4" × 18" × 25.9"
- ❖ **Weight:**
Approx. 20 kg, 44 lb.

Interposer

- ❖ **Paper size:**
A3 ☐, B4 JIS ☐, A4 ☐ ☐, B5 JIS ☐ ☐, A5 ☐ ☐, 11" × 17" ☐, 8¹/₂" × 14" ☐, 8¹/₂" × 11" ☐ ☐, 5¹/₂" × 8¹/₂" ☐ ☐
- ❖ **Paper weight:**
64 – 216 g/m², 17 – 58 lb.
- ❖ **Paper Capacity:**
200 sheets (80 g/m², 20 lb.)
- ❖ **Power consumption (Max):**
Approx. 48 W (power supplied from main unit)
- ❖ **Dimensions (W × D × H):**
500 × 620 × 200 mm, 19.7" × 24.4" × 7.9"
- ❖ **Weight:**
Approx. 12 kg, 26.5 lb.

Specifications for Others

❖ A3/11" × 17" Tray Unit Type 1075 (option)

You can load A3 or 11" × 17" paper in the tray 1 using this unit.

❖ B4 JIS/8¹/₂" × 14" Tray Unit (option)

You can load B4 JIS/A4 or 8¹/₂" × 14" paper in the large capacity tray (LCT) using this unit.

❖ Tab Sheet Holder (option)

You can use tab sheets with this holder.

❖ Output Jogger (Booklet Finisher, 3,000Sheet-50Sheet Staple Finisher) (option)

You can tidy the printout with Booklet Finisher or 3,000Sheet-50Sheet Staple Finisher.

- Paper size:
A3, B4, A4, B5, A5, 11"×17", 8¹/₂"×14",
8¹/₂"×11", 5¹/₂"×8¹/₂"
- Power consumption (Max):
16 W (power supplied from main unit)
- Dimensions (W × D × H):
108 × 452 × 130 mm, 4.3"×17.8"×5.2"
- Weight:
Approx. 2 kg, 4.4 lb.

❖ Output Jogger (3,000Sheet-100Sheet Staple Finisher) (option)

You can tidy the printout with 3,000Sheet-100Sheet Staple Finisher.

- Paper size:
A3, B4, A4, B5, 11"×17", 8¹/₂"×11"
- Power consumption (Max):
7 W (power supplied from main unit)
- Dimensions (W × D × H):
125×450×100 mm, 4.9"×17.8"×3.9"
- Weight:
Approx. 1.7 kg, 3.8 lb.

Information about Installed Software

expat

- The software including controller, etc. (hereinafter "software") installed on this product uses the expat under the conditions mentioned below.
- The product manufacturer provides warranty and support to the software of the product including the expat, and the product manufacturer makes the initial developer and copyright holder of the expat, free from these obligations.
- Information relating to the expat is available at:
<http://expat.sourceforge.net/>

Copyright (c) 1998, 1999, 2000 Thai Open Source Software Centre, Ltd. and Clark Cooper.

Copyright © 2001, 2002 Expat maintainers.

Permission is hereby granted, free of charge, to any person obtaining a copy of this software and associated documentation files (the "Software"), to deal in the Software without restriction, including without limitation the rights to use, copy, modify, merge, publish, distribute, sublicense, and/or sell copies of the Software, and to permit persons to whom the Software is furnished to do so, subject to the following conditions:

The above copyright notice and this permission notice shall be included in all copies or substantial portions of the Software.

THE SOFTWARE IS PROVIDED "AS IS", WITHOUT WARRANTY OF ANY KIND, EXPRESS OR IMPLIED, INCLUDING BUT NOT LIMITED TO THE WARRANTIES OF MERCHANTABILITY, FITNESS FOR A PARTICULAR PURPOSE AND NONINFRINGEMENT. IN NO EVENT SHALL THE AUTHORS OR COPYRIGHT HOLDERS BE LIABLE FOR ANY CLAIM, DAMAGES OR OTHER LIABILITY, WHETHER IN AN ACTION OF CONTRACT, TORT OR OTHERWISE, ARISING FROM, OUT OF OR IN CONNECTION WITH THE SOFTWARE OR THE USE OR OTHER DEALINGS IN THE SOFTWARE.

NetBSD

1. Copyright Notice of NetBSD

For all users to use this product:

This product contains NetBSD operating system:

For the most part, the software constituting the NetBSD operating system is not in the public domain; its authors retain their copyright.

The following text shows the copyright notice used for many of the NetBSD source code. For exact copyright notice applicable for each of the files/binaries, the source code tree must be consulted.

A full source code can be found at <http://www.netbsd.org/>.

All rights reserved.

Redistribution and use in source and binary forms, with or without modification, are permitted provided that the following conditions are met:

- ① Redistributions of source code must retain the above copyright notice, this list of conditions and the following disclaimer.
- ② Redistributions in binary form must reproduce the above copyright notice, this list of conditions and the following disclaimer in the documentation and/or other materials provided with the distribution.
- ③ All advertising materials mentioning features or use of this software must display the following acknowledgment:
This product includes software developed by The NetBSD Foundation, Inc. and its contributors.
- ④ Neither the name of The NetBSD Foundation nor the names of its contributors may be used to endorse or promote products derived from this software without specific prior written permission.

THIS SOFTWARE IS PROVIDED BY THE NETBSD FOUNDATION, INC. AND CONTRIBUTORS "AS IS" AND ANY EXPRESS OR IMPLIED WARRANTIES, INCLUDING, BUT NOT LIMITED TO, THE IMPLIED WARRANTIES OF MERCHANTABILITY AND FITNESS FOR A PARTICULAR PURPOSE ARE DISCLAIMED. IN NO EVENT SHALL THE FOUNDATION OR CONTRIBUTORS BE LIABLE FOR ANY DIRECT, INDIRECT, INCIDENTAL, SPECIAL, EXEMPLARY, OR CONSEQUENTIAL DAMAGES (INCLUDING, BUT NOT LIMITED TO, PROCUREMENT OF SUBSTITUTE GOODS OR SERVICES; LOSS OF USE, DATA, OR PROFITS; OR BUSINESS INTERRUPTION) HOWEVER CAUSED AND ON ANY THEORY OF LIABILITY, WHETHER IN CONTRACT, STRICT LIABILITY, OR TORT (INCLUDING NEGLIGENCE OR OTHERWISE) ARISING IN ANY WAY OUT OF THE USE OF THIS SOFTWARE, EVEN IF ADVISED OF THE POSSIBILITY OF SUCH DAMAGE.

2. Authors Name List

All product names mentioned herein are trademarks of their respective owners.

The following notices are required to satisfy the license terms of the software that we have mentioned in this document:

- This product includes software developed by the University of California, Berkeley and its contributors.
- This product includes software developed by Jonathan R. Stone for the NetBSD Project.
- This product includes software developed by the NetBSD Foundation, Inc. and its contributors.
- This product includes software developed by Manuel Bouyer.
- This product includes software developed by Charles Hannum.
- This product includes software developed by Charles M. Hannum.
- This product includes software developed by Christopher G. Demetriou.
- This product includes software developed by Tools GmbH.
- This product includes software developed by Terrence R. Lambert.

- This product includes software developed by Adam Glass and Charles Hannum.
- This product includes software developed by Theo de Raadt.
- This product includes software developed by Jonathan Stone and Jason R. Thorpe for the NetBSD Project.
- This product includes software developed by the University of California, Lawrence Berkeley Laboratory and its contributors.
- This product includes software developed by Christos Zoulas.
- This product includes software developed by Christopher G. Demetriou for the NetBSD Project.
- This product includes software developed by Paul Kranenburg.
- This product includes software developed by Adam Glass.
- This product includes software developed by Jonathan Stone.
- This product includes software developed by Jonathan Stone for the NetBSD Project.
- This product includes software developed by Winning Strategies, Inc.
- This product includes software developed by Frank van der Linden for the NetBSD Project.
- This product includes software developed for the NetBSD Project by Frank van der Linden
- This product includes software developed for the NetBSD Project by Jason R. Thorpe.
- The software was developed by the University of California, Berkeley.
- This product includes software developed by Chris Provenzano, the University of California, Berkeley, and contributors.

Sablotron

Sablotron (Version 0.82) Copyright © 2000 Ginger Alliance Ltd. All Rights Reserved

a) The application software installed on this product includes the Sablotron software Version 0.82 (hereinafter, "Sablotron 0.82"), with modifications made by the product manufacturer. The original code of the Sablotron 0.82 is provided by Ginger Alliance Ltd., the initial developer, and the modified code of the Sablotron 0.82 has been derived from such original code provided by Ginger Alliance Ltd.

b) The product manufacturer provides warranty and support to the application software of this product including the Sablotron 0.82 as modified, and the product manufacturer makes Ginger Alliance Ltd., the initial developer of the Sablotron 0.82, free from these obligations.

c) The Sablotron 0.82 and the modifications thereof are made available under the terms of Mozilla Public License Version 1.1 (hereinafter, "MPL 1.1"), and the application software of this product constitutes the "Larger Work" as defined in MPL 1.1. The application software of this product except for the Sablotron 0.82 as modified is licensed by the product manufacturer under separate agreement(s).

- d) The source code of the modified code of the Sablotron 0.82 is available at: <http://support-download.com/services/device/sablot/notice082.html>
- e) The source code of the Sablotron software is available at: <http://www.ginger-all.com>
- f) MPL 1.1 is available at: <http://www.mozilla.org/MPL/MPL-1.1.html>

JPEG LIBRARY

- The software installed on this product is based in part on the work of the Independent JPEG Group.

SASL

CMU libsassl

Tim Martin

Rob Earhart

Rob Siemborski

Copyright (c) 2001 Carnegie Mellon University. All rights reserved.

Redistribution and use in source and binary forms, with or without modification, are permitted provided that the following conditions are met:

- ① Redistributions of source code must retain the above copyright notice, this list of conditions and the following disclaimer.
- ② Redistributions in binary form must reproduce the above copyright notice, this list of conditions and the following disclaimer in the documentation and/or other materials provided with the distribution.
- ③ The name "Carnegie Mellon University" must not be used to endorse or promote products derived from this software without prior written permission. For permission or any other legal details, please contact:

Office of Technology Transfer
Carnegie Mellon University
5000 Forbes Avenue
Pittsburgh, PA 15213-3890
(412) 268-4387, fax: (412) 268-7395
tech-transfer@andrew.cmu.edu

- ④ Redistributions of any form whatsoever must retain the following acknowledgment:
"This product includes software developed by Computing Services at Carnegie Mellon University (<http://www.cmu.edu/computing/>)."

CARNEGIE MELLON UNIVERSITY DISCLAIMS ALL WARRANTIES WITH REGARD TO THIS SOFTWARE, INCLUDING ALL IMPLIED WARRANTIES OF MERCHANTABILITY AND FITNESS, IN NO EVENT SHALL CARNEGIE MELLON UNIVERSITY BE LIABLE FOR ANY SPECIAL, INDIRECT OR CONSEQUENTIAL DAMAGES OR ANY DAMAGES WHATSOEVER RESULTING FROM LOSS OF USE, DATA OR PROFITS, WHETHER IN AN ACTION OF CONTRACT, NEGLIGENCE OR OTHER TORTIOUS ACTION, ARISING OUT OF OR IN CONNECTION WITH THE USE OR PERFORMANCE OF THIS SOFTWARE.

MD4

Copyright (C) 1990-2, RSA Data Security, Inc. All rights reserved.

License to copy and use this software is granted provided that it is identified as the "RSA Data Security, Inc. MD4 Message-Digest Algorithm" in all material mentioning or referencing this software or this function.

License is also granted to make and use derivative works provided that such works are identified as "derived from the RSA Data Security, Inc. MD4 Message-Digest Algorithm" in all material mentioning or referencing the derived work.

RSA Data Security, Inc. makes no representations concerning either the merchantability of this software or the suitability of this software for any particular purpose. It is provided "as is" without express or implied warranty of any kind.

8

These notices must be retained in any copies of any part of this documentation and/or software.

MD5

Copyright (C) 1991-2, RSA Data Security, Inc. Created 1991. All rights reserved.

License to copy and use this software is granted provided that it is identified as the "RSA Data Security, Inc. MD5 Message-Digest Algorithm" in all material mentioning or referencing this software or this function.

License is also granted to make and use derivative works provided that such works are identified as "derived from the RSA Data Security, Inc. MD5 Message-Digest Algorithm" in all material mentioning or referencing the derived work.

RSA Data Security, Inc. makes no representations concerning either the merchantability of this software or the suitability of this software for any particular purpose. It is provided "as is" without express or implied warranty of any kind.

These notices must be retained in any copies of any part of this documentation and/or software.

Samba(Ver 3.0.4)

For SMB transmission, this machine uses Samba ver 3.0.4 (hereinafter referred to as Samba 3.0.4).

Copyright © Andrew Tridgell 1994-1998

This program is free software; you can redistribute it and/or modify it under the terms of the GNU General Public License as published by the Free Software Foundation; either version 2 of the License, or (at your option) any later version.

This program is distributed in the hope that it will be useful, but WITHOUT ANY WARRANTY; without even the implied warranty of MERCHANTABILITY or FITNESS FOR A PARTICULAR PURPOSE. See the GNU General Public License along with this program; if not, write to the Free Software Foundation, Inc., 675 Mass Ave, Cambridge, MA 02139, USA.

 **Note**

The source code for SMB transmission by this machine can be downloaded from the following website:

<http://support-download.com/services/scbs>

RSA BSAFE®



- This product includes RSA BSAFE® cryptographic or security protocol software from RSA Security Inc.
- RSA and BSAFE are registered trademarks of RSA Security Inc. in the United States and/or other countries.
- RSA Security Inc. All rights reserved.

Open SSL

Copyright (c) 1998-2004 The OpenSSL Project. All rights reserved.

Redistribution and use in source and binary forms, with or without modification, are permitted provided that the following conditions are met:

1. Redistributions of source code must retain the above copyright notice, this list of conditions and the following disclaimer.
2. Redistributions in binary form must reproduce the above copyright notice, this list of conditions and the following disclaimer in the documentation and/or other materials provided with the distribution.
3. All advertising materials mentioning features or use of this software must display the following acknowledgment: "This product includes software developed by the OpenSSL Project for use in the OpenSSL Toolkit. (<http://www.openssl.org/>)"
4. The names "OpenSSL Toolkit" and "OpenSSL Project" must not be used to endorse or promote products derived from this software without prior written permission. For written permission, please contact openssl-core@openssl.org.
5. Products derived from this software may not be called "OpenSSL" nor may "OpenSSL" appear in their names without prior written permission of the OpenSSL Project.
6. Redistributions of any form whatsoever must retain the following acknowledgment: "This product includes software developed by the OpenSSL Project for use in the OpenSSL Toolkit (<http://www.openssl.org/>)"

THIS SOFTWARE IS PROVIDED BY THE OpenSSL PROJECT "AS IS" AND ANY EXPRESSED OR IMPLIED WARRANTIES, INCLUDING, BUT NOT LIMITED TO, THE IMPLIED WARRANTIES OF MERCHANTABILITY AND FITNESS FOR A PARTICULAR PURPOSE ARE DISCLAIMED. IN NO EVENT SHALL THE OpenSSL PROJECT OR ITS CONTRIBUTORS BE LIABLE FOR ANY DIRECT, INDIRECT, INCIDENTAL, SPECIAL, EXEMPLARY, OR CONSEQUENTIAL DAMAGES (INCLUDING, BUT NOT LIMITED TO, PROCUREMENT OF SUBSTITUTE GOODS OR SERVICES; LOSS OF USE, DATA, OR PROFITS; OR BUSINESS INTERRUPTION) HOWEVER CAUSED AND ON ANY THEORY OF LIABILITY, WHETHER IN CONTRACT, STRICT LIABILITY, OR TORT (INCLUDING NEGLIGENCE OR OTHERWISE) ARISING IN ANY WAY OUT OF THE USE OF THIS SOFTWARE, EVEN IF ADVISED OF THE POSSIBILITY OF SUCH DAMAGE.

This product includes cryptographic software written by Eric Young (eay@cryptsoft.com). This product includes software written by Tim Hudson (tjh@cryptsoft.com).

Original SSLeay License

Copyright (C) 1995-1998 Eric Young (eay@cryptsoft.com) All rights reserved.

This package is an SSL implementation written by Eric Young (eay@cryptsoft.com).

The implementation was written so as to conform with Netscapes SSL.

This library is free for commercial and non-commercial use as long as the following conditions are aheared to. The following conditions apply to all code found in this distribution, be it the RC4, RSA, lhash, DES, etc., code; not just the SSL code. The SSL documentation included with this distribution is covered by the same copyright terms except that the holder is Tim Hudson (tjh@cryptsoft.com).

Copyright remains Eric Young's, and as such any Copyright notices in the code are not to be removed. If this package is used in a product, Eric Young should be given attribution as the author of the parts of the library used. This can be in the form of a textual message at program startup or in documentation (online or textual) provided with the package.

Redistribution and use in source and binary forms, with or without modification, are permitted provided that the following conditions are met:

1. Redistributions of source code must retain the copyright notice, this list of conditions and the following disclaimer.
2. Redistributions in binary form must reproduce the above copyright notice, this list of conditions and the following disclaimer in the documentation and/or other materials provided with the distribution.
3. All advertising materials mentioning features or use of this software must display the following acknowledgement: "This product includes cryptographic software written by Eric Young (eay@cryptsoft.com)" The word 'cryptographic' can be left out if the rouines from the library being used are not cryptographic related :-).
4. If you include any Windows specific code (or a derivative thereof) from the apps directory (application code) you must include an acknowledgement: "This product includes software written by Tim Hudson (tjh@cryptsoft.com)"

THIS SOFTWARE IS PROVIDED BY ERIC YOUNG "AS IS" AND ANY EXPRESS OR IMPLIED WARRANTIES, INCLUDING, BUT NOT LIMITED TO, THE IMPLIED WARRANTIES OF MERCHANTABILITY AND FITNESS FOR A PARTICULAR PURPOSE ARE DISCLAIMED. IN NO EVENT SHALL THE AUTHOR OR CONTRIBUTORS BE LIABLE FOR ANY DIRECT, INDIRECT, INCIDENTAL, SPECIAL, EXEMPLARY, OR CONSEQUENTIAL DAMAGES (INCLUDING, BUT NOT LIMITED TO, PROCUREMENT OF SUBSTITUTE GOODS OR SERVICES; LOSS OF USE, DATA, OR PROFITS; OR BUSINESS INTERRUPTION) HOWEVER CAUSED AND ON ANY THEORY OF LIABILITY, WHETHER IN CONTRACT, STRICT LIABILITY, OR TORT (INCLUDING NEGLIGENCE OR OTHERWISE) ARISING IN ANY WAY OUT OF THE USE OF THIS SOFTWARE, EVEN IF ADVISED OF THE POSSIBILITY OF SUCH DAMAGE.

The licence and distribution terms for any publically available version or derivative of this code cannot be changed. i.e this code cannot simply be copied and put under another distribution licence [including the GNU Public Licence.]

Open SSH

The licences which components of this software fall under are as follows. First, we will summarize and say that all components are under a BSD licence, or a licence more free than that.

OpenSSH contains no GPL code.

8

1)

Copyright (c) 1995 Tatu Ylonen <ylo@cs.hut.fi>, Espoo, Finland All rights reserved

As far as I am concerned, the code I have written for this software can be used freely for any purpose. Any derived versions of this software must be clearly marked as such, and if the derived work is incompatible with the protocol description in the RFC file, it must be called by a name other than "ssh" or "Secure Shell".

[Tatu continues]

However, I am not implying to give any licenses to any patents or copyrights held by third parties, and the software includes parts that are not under my direct control. As far as I know, all included source code is used in accordance with the relevant license agreements and can be used freely for any purpose (the GNU license being the most restrictive); see below for details.

[However, none of that term is relevant at this point in time. All of these restrictively licenced software components which he talks about have been removed from OpenSSH, i.e.,

- RSA is no longer included, found in the OpenSSL library
- IDEA is no longer included, its use is deprecated
- DES is now external, in the OpenSSL library
- GMP is no longer used, and instead we call BN code from OpenSSL
- Zlib is now external, in a library
- The make-ssh-known-hosts script is no longer included
- TSS has been removed
- MD5 is now external, in the OpenSSL library
- RC4 support has been replaced with ARC4 support from OpenSSL
- Blowfish is now external, in the OpenSSL library

[The licence continues]

Note that any information and cryptographic algorithms used in this software are publicly available on the Internet and at any major bookstore, scientific library, and patent office worldwide. More information can be found e.g. at "<http://www.cs.hut.fi/crypto>".

The legal status of this program is some combination of all these permissions and restrictions. Use only at your own responsibility. You will be responsible for any legal consequences yourself; I am not making any claims whether possessing or using this is legal or not in your country, and I am not taking any responsibility on your behalf.

NO WARRANTY

BECAUSE THE PROGRAM IS LICENSED FREE OF CHARGE, THERE IS NO WARRANTY FOR THE PROGRAM, TO THE EXTENT PERMITTED BY APPLICABLE LAW. EXCEPT WHEN OTHERWISE STATED IN WRITING THE COPYRIGHT HOLDERS AND/OR OTHER PARTIES PROVIDE THE PROGRAM "AS IS" WITHOUT WARRANTY OF ANY KIND, EITHER EXPRESSED OR IMPLIED, INCLUDING, BUT NOT LIMITED TO, THE IMPLIED WARRANTIES OF MERCHANTABILITY AND FITNESS FOR A PARTICULAR PURPOSE. THE ENTIRE RISK AS TO THE QUALITY AND PERFORMANCE OF THE PROGRAM IS WITH YOU. SHOULD THE PROGRAM PROVE DEFECTIVE, YOU ASSUME THE COST OF ALL NECESSARY SERVICING, REPAIR OR CORRECTION.

IN NO EVENT UNLESS REQUIRED BY APPLICABLE LAW OR AGREED TO IN WRITING WILL ANY COPYRIGHT HOLDER, OR ANY OTHER PARTY WHO MAY MODIFY AND/OR REDISTRIBUTE THE PROGRAM AS PERMITTED ABOVE, BE LIABLE TO YOU FOR DAMAGES, INCLUDING ANY GENERAL, SPECIAL, INCIDENTAL OR CONSEQUENTIAL DAMAGES ARISING OUT OF THE USE OR INABILITY TO USE THE PROGRAM (INCLUDING BUT NOT LIMITED TO LOSS OF DATA OR DATA BEING RENDERED INACCURATE OR LOSSES SUSTAINED BY YOU OR THIRD PARTIES OR A FAILURE OF THE PROGRAM TO OPERATE WITH ANY OTHER PROGRAMS), EVEN IF SUCH HOLDER OR OTHER PARTY HAS BEEN ADVISED OF THE POSSIBILITY OF SUCH DAMAGES.

2)

The 32-bit CRC compensation attack detector in deattack.c was contributed by CORE SDI S.A. under a BSD-style license.

Cryptographic attack detector for ssh - source code

Copyright (c) 1998 CORE SDI S.A., Buenos Aires, Argentina.

All rights reserved. Redistribution and use in source and binary forms, with or without modification, are permitted provided that this copyright notice is retained.

THIS SOFTWARE IS PROVIDED "AS IS" AND ANY EXPRESS OR IMPLIED WARRANTIES ARE DISCLAIMED. IN NO EVENT SHALL CORE SDI S.A. BE LIABLE FOR ANY DIRECT, INDIRECT, INCIDENTAL, SPECIAL, EXEMPLARY OR CONSEQUENTIAL DAMAGES RESULTING FROM THE USE OR MISUSE OF THIS SOFTWARE.

Ariel Futoransky <futo@core-sdi.com>

<<http://www.core-sdi.com>>

3)

One component of the ssh source code is under a 3-clause BSD license, held by the University of California, since we pulled these parts from original Berkeley code.

Copyright (c) 1983, 1990, 1992, 1993, 1995

The Regents of the University of California. All rights reserved.

Redistribution and use in source and binary forms, with or without modification, are permitted provided that the following conditions are met:

1. Redistributions of source code must retain the above copyright notice, this list of conditions and the following disclaimer.
2. Redistributions in binary form must reproduce the above copyright notice, this list of conditions and the following disclaimer in the documentation and/or other materials provided with the distribution.

3. Neither the name of the University nor the names of its contributors may be used to endorse or promote products derived from this software without specific prior written permission.

THIS SOFTWARE IS PROVIDED BY THE REGENTS AND CONTRIBUTORS ``AS IS" AND ANY EXPRESS OR IMPLIED WARRANTIES, INCLUDING, BUT NOT LIMITED TO, THE IMPLIED WARRANTIES OF MERCHANTABILITY AND FITNESS FOR A PARTICULAR PURPOSE ARE DISCLAIMED. IN NO EVENT SHALL THE REGENTS OR CONTRIBUTORS BE LIABLE FOR ANY DIRECT, INDIRECT, INCIDENTAL, SPECIAL, EXEMPLARY, OR CONSEQUENTIAL DAMAGES (INCLUDING, BUT NOT LIMITED TO, PROCUREMENT OF SUBSTITUTE GOODS OR SERVICES; LOSS OF USE, DATA, OR PROFITS; OR BUSINESS INTERRUPTION) HOWEVER CAUSED AND ON ANY THEORY OF LIABILITY, WHETHER IN CONTRACT, STRICT LIABILITY, OR TORT (INCLUDING NEGLIGENCE OR OTHERWISE) ARISING IN ANY WAY OUT OF THE USE OF THIS SOFTWARE, EVEN IF ADVISED OF THE POSSIBILITY OF SUCH DAMAGE.

4)

Remaining components of the software are provided under a standard 2-term BSD licence with the following names as copyright holders:

Markus Friedl

Theo de Raadt

Niels Provos

Dug Song

Kevin Steves

Daniel Kouril

Wesley Griffin

Per Allansson

Jason Downs

Solar Designer

Todd C. Miller

Redistribution and use in source and binary forms, with or without modification, are permitted provided that the following conditions are met:

1. Redistributions of source code must retain the above copyright notice, this list of conditions and the following disclaimer.
2. Redistributions in binary form must reproduce the above copyright notice, this list of conditions and the following disclaimer in the documentation and/or other materials provided with the distribution.

THIS SOFTWARE IS PROVIDED BY THE AUTHOR "AS IS" AND ANY EXPRESS OR IMPLIED WARRANTIES, INCLUDING, BUT NOT LIMITED TO, THE IMPLIED WARRANTIES OF MERCHANTABILITY AND FITNESS FOR A PARTICULAR PURPOSE ARE DISCLAIMED. IN NO EVENT SHALL THE AUTHOR BE LIABLE FOR ANY DIRECT, INDIRECT, INCIDENTAL, SPECIAL, EXEMPLARY, OR CONSEQUENTIAL DAMAGES (INCLUDING, BUT NOT LIMITED TO, PROCUREMENT OF SUBSTITUTE GOODS OR SERVICES; LOSS OF USE, DATA, OR PROFITS; OR BUSINESS INTERRUPTION) HOWEVER CAUSED AND ON ANY THEORY OF LIABILITY, WHETHER IN CONTRACT, STRICT LIABILITY, OR TORT (INCLUDING NEGLIGENCE OR OTHERWISE) ARISING IN ANY WAY OUT OF THE USE OF THIS SOFTWARE, EVEN IF ADVISED OF THE POSSIBILITY OF SUCH DAMAGE.

5)

Portable OpenSSH contains the following additional licenses:

c) Compatibility code (openbsd-compat)

Apart from the previously mentioned licenses, various pieces of code in the openbsd-compat/ subdirectory are licensed as follows:

Some code is licensed under a 3-term BSD license, to the following copyright holders:

Todd C. Miller

Theo de Raadt

Damien Miller

Eric P. Allman

The Regents of the University of California

Redistribution and use in source and binary forms, with or without modification, are permitted provided that the following conditions are met:

1. Redistributions of source code must retain the above copyright notice, this list of conditions and the following disclaimer.
2. Redistributions in binary form must reproduce the above copyright notice, this list of conditions and the following disclaimer in the documentation and/or other materials provided with the distribution.
3. Neither the name of the University nor the names of its contributors may be used to endorse or promote products derived from this software without specific prior written permission.

THIS SOFTWARE IS PROVIDED BY THE REGENTS AND CONTRIBUTORS ``AS IS" AND ANY EXPRESS OR IMPLIED WARRANTIES, INCLUDING, BUT NOT LIMITED TO, THE IMPLIED WARRANTIES OF MERCHANTABILITY AND FITNESS FOR A PARTICULAR PURPOSE ARE DISCLAIMED. IN NO EVENT SHALL THE REGENTS OR CONTRIBUTORS BE LIABLE FOR ANY DIRECT, INDIRECT, INCIDENTAL, SPECIAL, EXEMPLARY, OR CONSEQUENTIAL DAMAGES (INCLUDING, BUT NOT LIMITED TO, PROCUREMENT OF SUBSTITUTE GOODS OR SERVICES; LOSS OF USE, DATA, OR PROFITS; OR BUSINESS INTERRUPTION) HOWEVER CAUSED AND ON ANY THEORY OF LIABILITY, WHETHER IN CONTRACT, STRICT LIABILITY, OR TORT (INCLUDING NEGLIGENCE OR OTHERWISE) ARISING IN ANY WAY OUT OF THE USE OF THIS SOFTWARE, EVEN IF ADVISED OF THE POSSIBILITY OF SUCH DAMAGE.

Open LDAP

The OpenLDAP Public License Version 2.8, 17 August 2003

Redistribution and use of this software and associated documentation ("Software"), with or without modification, are permitted provided that the following conditions are met:

1. Redistributions in source form must retain copyright statements and notices,
2. Redistributions in binary form must reproduce applicable copyright statements and notices, this list of conditions, and the following disclaimer in the documentation and/or other materials provided with the distribution, and
3. Redistributions must contain a verbatim copy of this document.

The OpenLDAP Foundation may revise this license from time to time. Each revision is distinguished by a version number. You may use this Software under terms of this license revision or under the terms of any subsequent revision of the license.

THIS SOFTWARE IS PROVIDED BY THE OPENLDAP FOUNDATION AND ITS CONTRIBUTORS ``AS IS" AND ANY EXPRESSED OR IMPLIED WARRANTIES, INCLUDING, BUT NOT LIMITED TO, THE IMPLIED WARRANTIES OF MERCHANTABILITY AND FITNESS FOR A PARTICULAR PURPOSE ARE DISCLAIMED. IN NO EVENT SHALL THE OPENLDAP FOUNDATION, ITS CONTRIBUTORS, OR THE AUTHOR(S) OR OWNER(S) OF THE SOFTWARE BE LIABLE FOR ANY DIRECT, INDIRECT, INCIDENTAL, SPECIAL, EXEMPLARY, OR CONSEQUENTIAL DAMAGES (INCLUDING, BUT NOT LIMITED TO, PROCUREMENT OF SUBSTITUTE GOODS OR SERVICES; LOSS OF USE, DATA, OR PROFITS; OR BUSINESS INTERRUPTION) HOWEVER CAUSED AND ON ANY THEORY OF LIABILITY, WHETHER IN CONTRACT, STRICT LIABILITY, OR TORT (INCLUDING NEGLIGENCE OR OTHERWISE) ARISING IN ANY WAY OUT OF THE USE OF THIS SOFTWARE, EVEN IF ADVISED OF THE POSSIBILITY OF SUCH DAMAGE.

The names of the authors and copyright holders must not be used in advertising or otherwise to promote the sale, use or other dealing in this Software without specific, written prior permission. Title to copyright in this Software shall at all times remain with copyright holders.

OpenLDAP is a registered trademark of the OpenLDAP Foundation.

Copyright 1999-2003 The OpenLDAP Foundation, Redwood City, California, USA. All Rights Reserved. Permission to copy and distribute verbatim copies of this document is granted.

INDEX

-
- 1 Sided 2 Sided Auto Margin
 - TtoB*, 106
 - TtoT*, 106
 - 3,000Sheet-100Sheet Staple Finisher, 233
 - 3,000Sheet-50Sheet Staple Finisher, 231

A

- A3/11" 17" Tray Unit Type 1075, 239
- Accessing User Tools (System Settings), 3
- Address Book, 159
 - Change Order*, 71
 - Edit Title*, 71
 - Program / Change / Delete Group*, 71
 - Switch Title*, 71
- Address Book Management, 71
- ADF Original Table Elevation, 41
- Administrator Authentication Management, 71
- Administrator's E-mail Address, 65
- Administrator Tools / System Settings, 71
- AOF (Always On), 71
- Append CR to LF, 148
- Authentication Information, 167, 212
- Auto Continue, 141
- Auto Delete File in Document Server, 71
- Auto Delete Stored Print Jobs, 141
- Auto Delete Temporary Print Jobs, 141
- Auto Document Feeder, 226
- Auto Erase Memory Setting, 71
- Auto Image Density Priority, 95
- Auto Logout Timer, 52
- Auto Off Timer, 52
- Auto Specify Sender Name, 65
- Auto Tray Switching, 95

B

- B4 JIS/8 1/2" 14" Tray Unit, 239
- Back Cover Sheet Tray, 46
- Background Numbering, 111
- Back Margin
 - Left / Right*, 106
 - Top / Bottom*, 106
- Back Up / Restore Address Book, 71
- Bidirectional Communication, 59
- Bidirectional SCSI print, 60
- Blank Page Print, 141
- Booklet Finisher, 228
- Bypass Tray Setting Priority, 141

C

- Capture Server IPv4 Address, 65
- Change PDF Password, 151
- Changing a FTP Folder Destination, 190
- Changing a Group Name, 207
- Changing an E-mail Destination, 179
- Changing a Registered Name, 165
- Changing a User Code, 169
- Changing the Display Language, 217
- Changing the registered SMB Folder Destination, 185
- Channel, 62
- Checking the Wireless LAN Connection, 12
- Clearing the Counter, 175
- Clearing the Number of Prints, 175
- Collate Type, 141
- Communication Mode, 62
- Compression (Black White), 157
- Compression (Gray Scale), 157
- Configuration Page, 137
- Connect Copy Key Display, 95
- Connecting to the Ethernet Interface, 6
- Connecting to the IEEE 1284 Interface, 9
- Connecting to the IEEE 1394 Interface, 9
- Connecting to the IEEE 802.11b (Wireless LAN) Interface, 10
- Connecting to the Interface, 5
- Connecting to the USB Interface, 8
- Copier/Document Server Auto Reset Timer, 52
- Copier/Document Server Features / Edit, 106
- Copier/Document Server Features / General Features, 95
- Copier/Document Server Features / Input/Output, 122
- Copier/Document Server Features on Main and Sub-machines, 127
- Copier/Document Server Features / Reproduction Ratio, 102
- Copier/Document Server Features / Settings for the Document Server, 125
- Copier/Document Server Features / Stamp, 111
- Copies, 141
- Copy Back Cover, 106
- Copy Count Display, 41
- Copy Eject Face Method in Bypass Mode, 122
- Copy Eject Face Method in Glass Mode, 122
- Copy on Designating Page in Combine, 106
- Copy Order in Combine, 106

Copy Orientation in Duplex Mode, 95
Copy Quality, 95
Copy tray, 237
Counter, 220
Courier Font, 148
Customize Function
 Copier, 95
 Document Server Print, 95
 Document Server Storage, 95

D

Data Format, 150
Data Security for Copying, 71
Date Stamp, 116
DDNS Configuration, 55
DDNS Configuration (IEEE 1394), 60
Default Printer Language, 141
Default User Name / Password (Send), 65
Delete All Files in Document Server, 71
Delete All Logs, 71
Delete All Stored Print Jobs, 140
Delete All Temporary Print Jobs, 140
Delete Scanner Journal, 153
Deleting a FTP Folder Destination, 192
Deleting a Group, 208
Deleting a Group Within Another Group, 205
Deleting a NCP Folder Destination, 198
Deleting an E-mail Destination, 180
Deleting a Registered Name, 166
Deleting a User Code, 171
Delivery Option, 65
Density (Background Numbering), 111
Designation Sheet 1 Tray, 46
Designation Sheet 2 Tray, 46
Destination List Display Priority 1, 153
Destination List Display Priority 2, 153
Display / Clear / Print Counter per User, 71
Displaying Names Registered in a Group, 203
Displaying the Counter for Each User, 172
Display panel, 2
Display / Print Counter, 71
Divide Send E-mail, 157
DNS Configuration, 55
Document Server, 225
Domain Name, 55
Domain Name (IEEE 1394), 60
Double Copies Separation Line, 106
Duplex, 141
Duplex Back Page Stamping Position
 (Page Numbering), 117

E

Edge to Edge Print, 141
Edit / Copier/Document Server Features, 106
Effective Protocol, 55
E-mail Communication Port, 65
E-mail Destination, 177
E-mail Information Language, 157
E-mail Reception Interval, 65
E-mail Storage in Server, 65
Energy Saver Timer, 52
Enhanced Authentication Management, 71
Enquiry, 218
Erase All Memory, 71
Erase Border Width, 106
Erase Centre Width, 106
Erase Original Shadow in Combine, 106
Error Log, 137
Ethernet Speed, 55
Extend A4 Width, 148
Extended Security, 71

F

File Transfer / System Settings, 65
Firmware Version, 71
Folder Destination, 181
Font (Date Stamp), 116
Font Number, 148
Font (Page Numbering), 117
Font Pitch, 148
Font Source, 148
Font (Stamp Text), 120
Format (Date Stamp), 116
Form Lines, 148
Front Cover Copy in Combine, 106
Front Cover Sheet Tray, 46
Front Margin
 Left / Right, 106
 Top / Bottom, 106
Function Priority, 41
Function Reset Timer, 41

G

General Features / Copier/Document
 Server Features, 95
General Features / System Settings, 41
General Settings / Scanner Features, 153

H

Hex Dump, 137
Host Interface / Printer Features, 147
Host Name, 55
Host Name (IEEE 1394), 60

I

IEEE 1394, 60
IEEE 802.11b, 13, 62
Image Density, 95
Image Repeat Separation Line, 106
Initial Print Job List, 141
Input/Output / Copier/
Document Server Features, 122
Input Prime, 59
Interface Settings / System Settings, 55
Interleave Print, 41
Interposer, 238
Interpreting the configuration page, 138
I/O Buffer, 147
I/O Timeout, 147
IPv4 Address (IEEE 1394), 60
IPv4 Gateway Address, 55
IPv4 over 1394, 60
IPv6 Gateway Address, 55
IPv6 Stateless Address
Autoconfiguration, 55

J

Job End Call, 95
Job Separation, 141

K

Key Counter Management, 71
Key Repeat, 41

L

LAN Type, 55
Large Capacity Tray (LCT), 238
LDAP Authentication, 214
LDAP Search, 71
Letterhead Setting, 122, 141
List / Test Print Lock, 140
List/Test Print / Printer Features, 137

M

Machine IPv4 Address, 55
Machine IPv6 Address, 55
Machine Name, 55
Mailbox, 227
Maintenance / Printer Features, 140
Max. Copy Quantity, 95
Max. E-mail Size, 157
Max. Reception E-mail Size, 65
Memory Full Auto Scan Restart, 122
Memory Overflow, 141
Memory Usage, 141
Menu List, 137
Multiple Lists, 137

N

NCP Delivery Protocol, 55
Network, 55
Network Security Level, 71
Network Settings, 14
No. of Digits for Single Page Files, 157
Number of Scanner Resends, 65
NW Frame Type, 55

O

Orientation, 148
Booklet, Magazine, 106
Original Orientation in Duplex Mode, 95
Original Type Display, 95
Output
Copier, 41
Document Server, 41
Printer, 41
Output Jogger, 239
Output Jogger (3,000Sheet-100Sheet
Staple Finisher), 239
Output tray settings, 45

P

Page Numbering, 117
Page Numbering in Combine (Page
Numbering), 117
Page Numbering Initial Letter, 117
Page Size, 141
Panel Key Sound, 41
Panel Off Timer, 52
Paper Display, 95
Paper Tray Priority
Copier, 46
Printer, 46

- Paper Type
 - Bypass Tray*, 46
 - Tray 1*, 46
 - Tray 2*, 46
 - Tray 3*, 46
- Parallel Communication Speed, 59
- Parallel Interface, 59
- Parallel Timing, 59
- PCL Configuration / Font Page, 137
- PCL Menu / Printer Features, 148
- PDF Configuration / Font Page, 137
- PDF Group Password, 151
- PDF Menu / Printer Features, 151
- Permit SNMPv3 Communication, 55
- Permit SSL / TLS Communication, 55
- Ping Command, 55
- Point Size, 148
- POP3 / IMAP4 Settings, 65
- POP before SMTP, 65
- Preheating level setting, 71
- Preset Stamp, 112
- Print Address Book
 - Destination List*, 71
- Print Backup
 - Compression*, 71
 - Default Format*, 71
 - Default Resolution*, 71
 - Delete All Files*, 71
- Print Delete Scanner Journal, 153
- Printer Auto Reset Timer, 52
- Printer Bypass Paper Size, 46
- Printer Features / Host Interface, 147
- Printer Features / List/Test Print, 137
- Printer Features / Maintenance, 140
- Printer Features / PCL Menu, 148
- Printer Features / PDF Menu, 151
- Printer Features / PS Menu, 150
- Printer Features / System, 141
- Printer Language, 141
- Print Error Report, 141
- Printing the configuration page, 138
- Printing the Counter for All User, 174
- Printing the Counter for Each User, 173
- Print List, 64
- Print Priority, 41
- Print Scanner Journal, 153
- Program / Change Administrator, 71
- Program / Change / Delete E-mail Message, 65
- Program / Change / Delete LDAP Server, 71, 80
- Program / Change / Delete User Text, 41
- Program / Delete Stamp (User Stamp), 114
- Programming the LDAP server, 81

- PS Configuration / Font Page, 137
- PS Menu / Printer Features, 150
- Punch Type, 122
- Punch Unit (3,000Sheet-100Sheet Staple Finisher), 236
- Punch Unit (Booklet Finisher, 3,000Sheet-50Sheet Staple Finisher), 235

R

- Ratio for Create Margin, 102
- Reception Protocol, 65
- Registering a FTP Folder Destination, 188
- Registering a Group, 199
- Registering a NCP Folder Destination, 193
- Registering an E-mail Destination, 177
- Registering an SMB Folder Destination, 182
- Registering a Protection Code, 209
- Registering a Protection Code to a Group User, 211
- Registering a Protection Code to a Single User, 209
- Registering a User Code, 168
- Registering Folders, 181
- Registering LDAP Authentication, 212, 214
- Registering Names, 163
- Registering Names to a Group, 199, 201
- Registering SMTP Authentication, 212
- Removing a Name from a Group, 204
- Reproduction Ratio / Copier/Document Server Features, 102
- R / E Ratio, 102
- R / E Ratio Priority, 102
- Reserved Job Waiting Time, 141
- Resolution, 148, 150, 151
- Restore Factory Defaults, 62
- Rotate Sort
 - Auto Paper Continue*, 122

S

- SADF Auto Reset, 122
- Scanner Auto Reset Timer, 52
- Scanner Features / General Settings, 153
- Scanner Features / Scan Settings, 155
- Scanner Features / Send Settings, 157
- Scanner Resend Interval Time, 65
- Scan Settings / Scanner Features, 155
- SCSI print (SBP-2), 60
- Search Destination, 153
- Security Method, 62
- Selection Signal Status, 59
- Send Settings / Scanner Features, 157
- Separation Line in Combine, 106
- Set Date, 52

- Set Time, 52
- Settings for the Document Server / Copier/Document Server Features, 125
- Settings Required to Use Document Server, 30
- Settings Required to Use Document Server / Ethernet, 30
- Settings Required to Use Document Server / IEEE 1394 (IPv4 over 1394), 31
- Settings Required to Use Document Server / IEEE 802.11b (wireless LAN), 32
- Settings Required to Use E-mail Function / Ethernet, 17
- Settings Required to Use E-mail Function / IEEE 1394 (IPv4 over 1394), 18
- Settings Required to Use E-mail Function / IEEE 802.11b (wireless LAN), 19
- Settings Required to Use Network TWAIN Scanner, 27
- Settings Required to Use Network TWAIN Scanner / Ethernet, 27
- Settings Required to Use Network TWAIN Scanner / IEEE 1394 (IPv4 over 1394), 28
- Settings Required to Use Network TWAIN Scanner / IEEE 802.11b (wireless LAN), 29
- Settings Required to Use Scan to Folder Function, 21
- Settings Required to Use Scan to Folder Function / Ethernet, 21
- Settings Required to Use Scan to Folder Function / IEEE 1394 (IPv4 over 1394), 22
- Settings Required to Use Scan to Folder Function / IEEE 802.11b (wireless LAN), 23
- Settings Required to Use the Network Delivery Scanner, 24
- Settings Required to Use the Network Delivery Scanner / Ethernet, 24
- Settings Required to Use the Network Delivery Scanner / IEEE 1394 (IPv4 over 1394), 25
- Settings Required to Use the Network Delivery Scanner / IEEE 802.11b (wireless LAN), 26
- Settings Required to Use the Printer, 14
- Settings Required to Use the Printer / Ethernet, 14
- Settings Required to Use the Printer / IEEE 1394 (IPv4 over 1394), 15
- Settings Required to Use the Printer / IEEE 802.11b (wireless LAN), 16
- Setup IEEE 802.11b, 11
- Setup Wireless LAN, 11
- Shortcut R / E, 102
- Signal Control, 59
- Simplified Screen
 - Finishing Types*, 122
- Size (Background Numbering), 111
- Size (Date Stamp), 116
- Size (Page Numbering), 117
- Size (Stamp Text), 120
- Slip Sheet Tray, 46
- SMB Computer Name, 55
- SMB Work Group, 55
- SMTP Authentication, 65, 212
- SMTP Server, 65
- Specifications, 221, 227, 239
- Specifications for Options, 227
- Specifications for Others, 239
- Specifications for the Main Unit, 221
- SSID Setting, 62
- Stamp / Copier/Document Server Features, 111
- Stamp Format
 - 1 (User Stamp), 114
 - 2 (User Stamp), 114
 - 3 (User Stamp), 114
 - 4 (User Stamp), 114
- Stamp Format (Page Numbering), 117
- Stamp Format (Preset Stamp), 112
- Stamp Language (Preset Stamp), 112
- Stamp on Designating Slip Sheet (Page Numbering), 117
- Stamp Position (Page Numbering), 117
- Stamp Priority (Preset Stamp), 112
- Stamp Setting (Date Stamp), 116
- Stamp Setting (Stamp Text), 120
- Stamp Text, 120
- Staple Position, 122
- Staple Type, 141
- Stored File E-mail Method, 157
- Sub Paper Size, 141
- Superimpose (Date Stamp), 116
- Superimpose (Page Numbering), 117
- Superimpose (Stamp Text), 120
- Switch Original Counter Display, 95
- Switch Title, 153
- Switch to Batch, 122
- Symbol Set, 148
- System Auto Reset Timer, 52
- System / Printer Features, 141
- System Settings / Administrator Tools, 71
- System Settings / File Transfer, 65
- System Settings / General Features, 41
- System Settings / Interface Settings, 55
- System Settings on Main and Sub-machines / System Settings, 86

System Settings / System Settings on
Main and Sub-machines, 86
System Settings / Timer Settings, 52
System Settings / Tray Paper Settings, 46
System Status/Job List Display Time, 41

T

Tab Sheet Holder, 239
Timer Settings / System Settings, 52
To enter an identification name, 81
To enter a port number, 82
To enter a server name, 81
To enter the search base, 81
To enter the user name and password, 83
Tone
 Original Remains, 95
Toner Saving, 141
To set authentication, 82
To set search conditions, 84
To set search options, 84
To start SSL communication, 82
To test the connection, 83
Transfer Log Setting, 71
Transmission Speed, 62
Tray Paper Settings / System Settings, 46
Tray Paper Size
 Tray 2, 46
 Tray 3, 46
Tray Switching, 141
TWAIN Standby Time, 153

U

Update Delivery Server Destination List, 153
User Authentication Management, 71
User Code, 167
User Stamp, 114
Using SMB to Connect, 181
Using Utilities to Make Settings, 33

W

Wait Time for Next Orig.
 Exposure Glass, 155
Wait Time for Next Original(s)
 SADF, 155
Warm-up Beeper, 41
Weekly Timer
 Monday - Sunday, 52
Weekly Timer Code, 52
WINS Configuration, 55
WINS Configuration (IEEE 1394), 60
Wireless LAN Signal, 62

Z

Z-folding unit, 237
Z-fold position, 41

In accordance with IEC 60417, this machine uses the following symbols for the main power switch:

I means POWER ON.

⏻ means STAND BY.

Trademarks

Microsoft®, Windows® and Windows NT® are registered trademarks of Microsoft Corporation in the United States and/or other countries.

Acrobat® is a registered trademark of Adobe Systems Incorporated.

NetWare is a registered trademark of Novell, Inc.

Other product names used herein are for identification purposes only and might be trademarks of their respective companies. We disclaim any and all rights to those marks.

The proper names of the Windows operating systems are as follows:

The product name of Windows® 95 is Microsoft® Windows® 95

The product name of Windows® 98 is Microsoft® Windows® 98

The product name of Windows® Me is Microsoft® Windows® Millennium Edition (Windows Me)

The product names of Windows® 2000 are as follows:

Microsoft® Windows® 2000 Advanced Server

Microsoft® Windows® 2000 Server

Microsoft® Windows® 2000 Professional

The product names of Windows® XP are as follows:

Microsoft® Windows® XP Professional

Microsoft® Windows® XP Home Edition

The product names of Windows Server™ 2003 are as follows:

Microsoft® Windows Server™ 2003 Standard Edition

Microsoft® Windows Server™ 2003 Enterprise Edition

Microsoft® Windows Server™ 2003 Web Edition

The product names of Windows® NT are as follows:

Microsoft® Windows NT® Server 4.0

Microsoft® Windows NT® Workstation 4.0

